



**Italian Submersible Motors**

---



# contents

## 01 PM: who, what, how, where, why

---

pg. 78-87

## 02 Our product range

---

pg. 89-91	<b>4OM</b> 4" rewindable oil filled submersible motors
pg. 92-93	<b>4OM2W</b> 4" 1-phase 2-wire oil filled submersible motors
pg. 94-97	<b>6OM</b> 6" rewindable oil filled submersible motors
pg. 99-101	<b>4WM</b> 4" water cooled submersible motors, canned type
pg. 102-103	<b>4WM2W</b> 4" 1-phase 2-wire water cooled submersible motors, canned type
pg. 104-106	<b>4WMU</b> 4" water cooled submersible motors, canned type
pg. 108-109	<b>4WMU2W</b> 4" 1-phase 2-wire water cooled submersible motors, canned type
pg. 110-114	<b>6WMI/6WM</b> 6" rewindable water cooled submersible motors
pg. 116-120	<b>8WM</b> 8" rewindable water cooled submersible motors
pg. 122-127	<b>4OME</b> 4" variable speed submersible motors with inverter on-board
pg. 128-131	<b>4OME SOLAR</b> 4" solar-powered submersible motors with inverter on-board
pg. 133-137	<b>FROG</b> 5" submersible monoblock electropumps
pg. 139-143	<b>E.S.P., C-BOX, CU-BOX and WHITE</b> Control panels
pg. 144-146	<b>ACCESSORIES</b>

## 03 Charts

---

pg. 150	Cables sizing charts
pg. 151	Units conversion charts

## 04 General sales conditions

---

pg. 153



## who we are

PM S.r.l. was established in 2008 to then quickly become one of the leading Italian and international companies operating in the production of submersible motors.

Our strengths are based on over 30 years of experience of the founding partner applied to the most modern technologies and an in-depth knowledge of international markets.

As a result PM has managed to establish itself as a modern, dynamic company focusing on continuous improvement. Each PM product is the expression of careful and enthusiastic work based on research and design with exclusive attention to performance, quality of the materials used and highest competitiveness possible. The result is an extremely reliable and efficient product range in which every detail is carefully researched, all distinguishing features of Made in Italy excellence. These key elements which embody profound love for an art passed down from father to son currently guide PM S.r.l.

PM is committed to offering high quality and reliable products at a competitive price, while meeting the needs of its customers with meticulous and punctual service. Substantial annual investments in product, production process and machinery innovation go with our daily activity to make our products ever more competitive and efficient.



**ISO 9001:2015 Certified Company**

## what we make

PM S.r.l. offers submersible motors and electro-pumps to get underground clean water, having about **150.000 items** produced per year.

The use of very high quality **MADE IN ITALY** materials and our strict tests, together with consolidated know how, ensure products characterised by high mechanical resistance and high performing electric features.

Our product range consists of:

- **4" and 6" rewindable oil filled submersible motors;**
- **4" water cooled submersible motors, canned type;**
- **6" and 8" rewindable water cooled submersible motors;**
- **5" submersible monoblock electropumps.**

In addition to these traditional products, PM S.r.l. offers also innovative 4" submersible motors:

- **4" variable speed submersible motors with inverter on-board;**
- **4" solar-powered submersible motors with inverter on-board.**

Finally, our control panels series for protection and control of motors, **E.S.P.**, **C-BOX**, **CU-BOX** and **WHITE**, and our **accessories** complete PM products range.



Made in Italy



# how we make it

PM S.r.l. is used to work to make PM Technology brand the perfect Partner for its **Customers**, both **Distributors** and **OEM**, through the supply of high quality, reliable and competitive products by ensuring a high standard of service.

To achieve this goal, all the company is constantly improving to pursue the highest possible level of quality.

You can breathe quality in all company levels, in all its process and in all the resources involved.

## But, what does it mean?

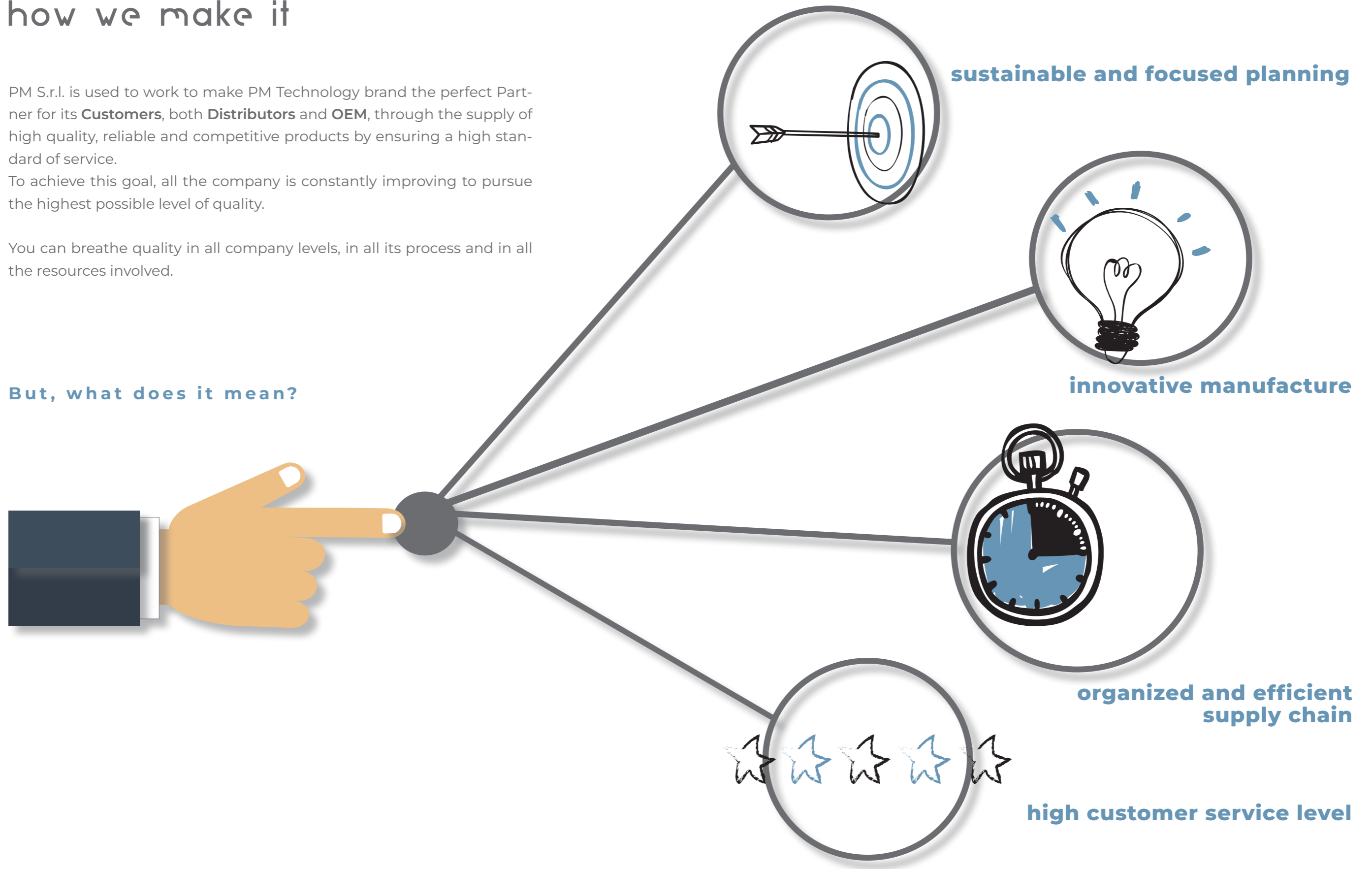

where we make it

**3 production plants**  
located in Vicenza (Italy),  
district of excellence of engineering industry.

From here our product range  
is exported in more than  
**60 countries.**

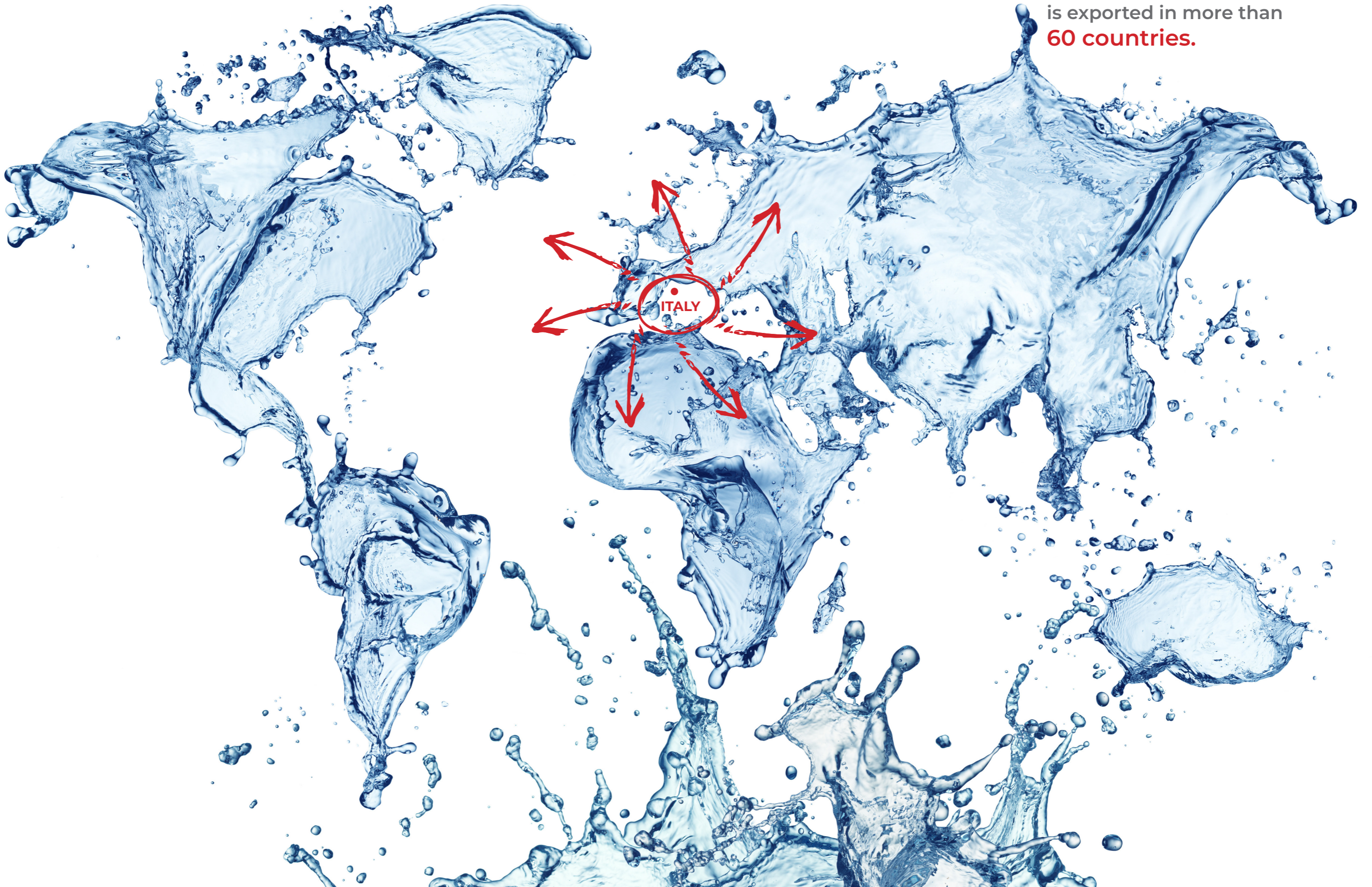

why we make it

“ Water is life’s matter and matrix,  
mother and medium.  
There is no life without water. ”

Albert Szent-Gyorgyi





# 40M

50 Hz - 60 Hz

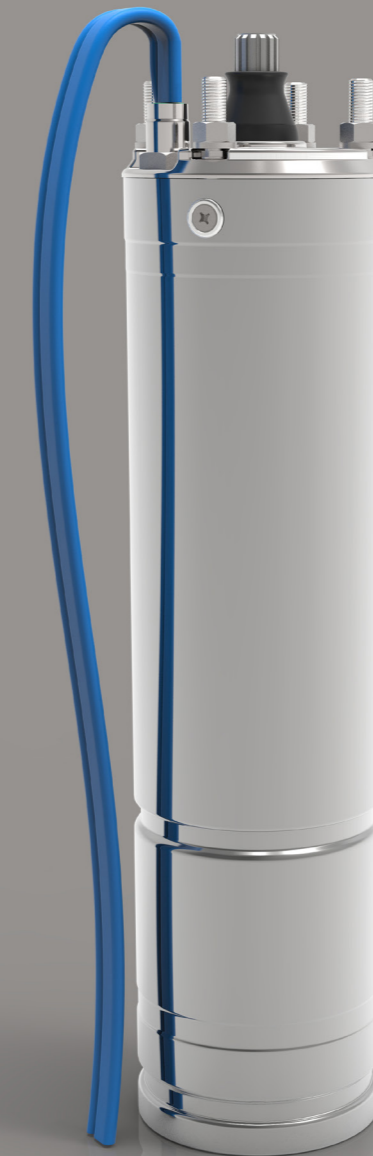

**Oil filled  
submersible motors**



Made in Italy

**4" REWINDABLE OIL FILLED  
SUBMERSIBLE MOTORS**

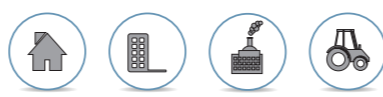

**TECHNICAL SPECIFICATIONS**

**REWINDABLE MOTORS**

**MOTOR/PUMP FLANGE**  
4" NEMA STANDARD

**POWERS**  
Single-phase: from 0,5 to 5,5 Hp  
Three-phase: from 0,5 to 10 Hp

**VOLTAGE**  
Single-phase: 230 V / 50 Hz - 110;220 V / 60 Hz  
Three-phase: 230;400 V / 50 Hz - 220;380 V / 60 Hz

**THRUST LOAD**  
From 0,5 to 3 Hp: 2000 N  
From 3 to 4 Hp: 3000 N  
From 5,5 to 10 Hp: 5000 N

**CONSTRUCTION FEATURES**

**PARTS IN CONTACT WITH WATER** all made in AISI 304 stainless steel.

**EXTERNAL SLEEVE AND BOTTOM** made in AISI 304 stainless steel. More specifically, sleeve is made of AISI 304L (Low carbon) to avoid possible corrosions of the welding.

**UPPER BRACKET** made in cast iron with cataphoresis treatment and protected with an AISI 304 stainless steel cover. Sleeve clamping is ensured by 4 inserts in low power motors and 6 inserts in motors bigger than 3 Hp.

**MECHANICAL SEAL** made in graphite/ceramic in the standard version; SIC-SIC version available upon request.

**BALL BEARING** duly oversized to ensure a long lasting motor.

**STATOR** with 24 slots, specifically developed to achieve maximum electrical yield. Airtight sealed and immersed in selected mineral white and highly refined oil, suitable to be used in drinking water (F.D.A., Food and Drug Administration, approved).

**REMOVABLE POWER CABLE-CONNECTOR** to ensure a perfect sealing, also in the most critical conditions, and to aid maintenance operations. More specifically, the connector prevents oil from rising in the conductors up to the joint, thus enabling immersion at greater depths. The power cable complies with all major standards on the use in drinking water (KTW, ACS, WRAS).

**SHAFT** made in carbon-steel alloys in the rotor area, to foster electrical features. AISI 304 stainless steel projection. DUPLEX, a special type of stainless steel, replaces AISI 304 in motors bigger than 3 Hp. This steel combines excellent resistance to corrosion and high mechanical resistance, which is necessary where starting torque becomes really important.

**SAND PROTECTION FILTER** in addition to the standard sand protection system. It's a special filter that stops any impurities that may get in contact with the external face of mechanical seal. This ensures a longer mechanical seal lifetime.

**100% TESTED**, all motors are tested at the end of the line. Seal and electrical checks are carried out on all motors.

**VERSIONS UPON REQUEST**

Different thrust loads  
Different voltage  
Sic-Sic mechanical seal

**OPERATING LIMITS**

**DEGREE OF PROTECTION**  
IP 68

**INSULATION CLASS**  
F

**VOLTAGE TOLERANCE**  
-10% / +10%

**PUMPED LIQUID TEMPERATURE**  
0°C – 35°C

**MIN. COOLING FLOW**  
0,1 m/s

**MAX. STARTS / HOUR**  
30

**MOUNTING**  
Vertical and/or horizontal

**MAX. IMMERSION DEPTH**  
200 m

**SINGLE-PHASE VERSION**  
PSC type (Permanent Split Capacitor).

**ACCESSORIES** refer to page 147 - 148 - 152 - 153

Different cable lengths  
Sacrificial anode  
Capacitors  
Control panels

**DIMENSIONS**

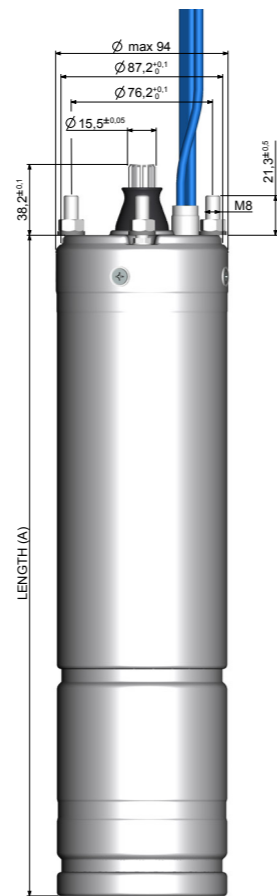

**ELECTRICAL DATA 4OM - 50Hz**

Type	P <sub>2</sub> [Hp]	P <sub>2</sub> [kW]	Voltage [V]	Ph	I <sub>n</sub> [A]	I <sub>max</sub> [A]	I <sub>avv</sub> [A]	rpm	cos φ	η [%]	Capacitor [μF]	Thrust Load [N]	Length A [mm]	Weight [kg]	Cable Length [m]	Cable Section [mm²]
4OM-S050	0,5	0,37	230	1	3,6	12	2810	0,87	52	20	2000	311,3	6,45	1,7	4 x 1,5	
4OM-S075	0,75	0,55	230	1	4,7	16,5	2810	0,88	57	25	2000	331,4	7,2	1,7	4 x 1,5	
4OM-S100	1	0,75	230	1	5,9	18,9	2825	0,9	62	35	2000	356,4	8,45	1,7	4 x 1,5	
4OM-S150	1,5	1,1	230	1	8,3	26,2	2840	0,91	64	40	2000	396,4	10,2	1,7	4 x 1,5	
4OM-S200	2	1,5	230	1	10,7	35	2845	0,93	66	60	2000	436,5	11,65	1,7	4 x 1,5	
4OM-S300	3	2,2	230	1	15,2	47	2820	0,93	67	80	2000	491,5	14,9	1,7	4 x 1,5	
											3000	505	15,1			
4OM-S400	4	3	230	1	20,4	86	2850	0,94	72	90	5000	505	15,1	2,7	4 x 2	
4OM-S500	5	3,7	230	1	24,5	95	2810	0,95	73	100+250/300	5000	700,2	24,15	2,7	4 x 2	
4OM-S550	5,5	4	230	1	25,1	104	2840	0,96	73	120+250/300	5000	800,2	28,95	2,7	4 x 2	
4OM-T050	0,5	0,37	230	3	2,2	8,9	2855	0,75	57	-	2000	311,3	6,45	1,7	4 x 1,5	
			400		1,8	5,8	2850	0,54	58							
4OM-T075	0,75	0,55	230	3	3,4	13,5	2830	0,70	62	-	2000	331,4	7,2	1,7	4 x 1,5	
			400		2	8	2835	0,65	63							
4OM-T100	1	0,75	230	3	4,1	15,5	2820	0,74	62	-	2000	356,4	8,45	1,7	4 x 1,5	
			400		2,5	9,4	2825	0,77	63							
4OM-T150	1,5	1,1	230	3	5,9	25	2825	0,68	68	-	2000	371,4	9,35	1,7	4 x 1,5	
			400		3,4	15,5		0,69								
4OM-T200	2	1,5	230	3	8,2	27,5	2830	0,64	70	-	2000	396,4	10,2	1,7	4 x 1,5	
			400		4,8	18	2835	0,63	71							
4OM-T300	3	2,2	230	3	10,6	39,5	2815	0,70	72	-	2000	436,5	11,65	1,7	4 x 1,5	
			400		6,1	39,5	2810	0,69			3000	450	11,9			
											2000	436,5	11,65			
											3000	450	11,9			
4OM-T400	4	3	230	3	12,8	39,5	2830	0,81	75	-	3000	450	12,1	1,7	4 x 1,5	
			400		7,1	39,5	2835	0,69								
4OM-T550	5,5	4	230	3	15,6	86	2840	0,83	76	-	5000	505	15,1	2,7	4 x 2	
			400		9,2	49,5	2845									
4OM-T750	7,5	5,5	230	3	22,7	109	2825	0,78	78	-	5000	589	19,8	2,7	4 x 2	
			400		12,3	64	2830	0,82								
4OM-T1000	10	7,5	400	3	16,4	88	2840	0,81	81	-	5000	800,2	28,95	2,7	4 x 2	

**ELECTRICAL DATA 4OM - 60Hz**

Type	P <sub>2</sub> [Hp]	P <sub>2</sub> [kW]	Voltage [V]	Ph	I <sub>n</sub> [A]	I <sub>max</sub> [A]	I <sub>avv</sub> [A]	rpm	cos φ	η [%]	Capacitor [μF]	S.F.	Thrust Load [N]	Length A [mm]	Weight [kg]	Cable Length [m]	Cable Section [mm²]
4OM-S050	0,5	0,37	220	1	3,4	4,2	16	3450	0,92	54	20	1,6	2000	331,4	7,2	1,7	4 x 1,5
			110		6,8	9,9	29	3470	0,89	48	80						
4OM-S075	0,75	0,55	220	1	4,7	6,8	20,2	3420	0,95	57	25	1,5	2000	331,4	7,2	1,7	4 x 1,5
			110		9,9	13,1	39	3435	0,84	53	100						
4OM-S100	1	0,75	220	1	6,1	8,1	22,6	3435	0,95	58	35	1,4	2000	356,4	8,45	1,7	4 x 1,5
			110		11,8	15,6	48	3445	0,89	61	120						
4OM-S150	1,5	1,1	220	1	8,3	10,8	32	3455	0,98	64	40	1,3	2000	396,4	10,2	1,7	4 x 1,5
			110		15,4	19,2	72	3430	0,91	63	140						
4OM-S200	2	1,5	220	1	10,8	13,3	41	3445	0,95	67	60	1,25	2000	436,5	11,65	1,7	4 x 1,5
													2000	491,5	14,9		
4OM-S300	3	2,2	220	1	15,5	16,6	47	3425	0,96	68	80	1,15	3000	505	15,1	1,7	4 x 1,5
													5000	700,2	24,15	2,7	4 x 2
4OM-S500	5	3,7	220	1	24,1	27,2	92	3460	0,93	72	100+250/300	1,15	5000	800,2	28,95	2,7	4 x 2
4OM-S550	5,5	4	220	1	26,2	30,8	107	3430	0,93	73	120+250/300	1,15	5000	800,2	28,95	2,7	4 x 2
4OM-T050	0,5	0,37	220	3	2	2,9	11,5	3455	0,56	59	-	1,6	2000	331,4	7,2	1,7	4 x 1,5
			380		1,2	1,6	10,5		0,77								
4OM-T075	0,75	0,55	220	3	3,2	4,1	19	3450	0,55	64	-	1,5	2000	331,4	7,2	1,7	4 x 1,5
			380		1,9	2,3	11,5		0,72								
4OM-T100	1	0,75	220	3	4,5	5,3	26,5	3460	0,62	67	-	1,4	2000	356,4	8,45	1,7	4 x 1,5
			380		2,7	3	16,5		0,72								
4OM-T150	1,5	1,1	220	3	5,7	5,9	35	3440	0,63	68	-	1,3	2000	371,4	9,35	1,7	4 x 1,5
			380		3,9	4,3	21,5		0,68								
4OM-T200	2	1,5	220	3	6,8	8,2	43	3445	0,67	71	-	1,25	2000	396,4	10,2	1,7	4 x 1,5
			380		4,5	5,1	24,5		0,75								
4OM-T300	3	2,2	220	3	9,6	10,6	51	3430	0,73	72	-	1,15	2000	436,5	11,65	1,7	4 x 1,5
			380		6,7	7,4	30	3430	0,72				3000	450	11,90		
													2000	436,5	11,65		
													3000	450	11,90		
4OM-T400	4	3	220	3	13,4	15,2	73	3450	0,73	74	-	1,15	3000	450	12,1	1,7	4 x 1,5
			380		8,3	8,8	41										
4OM-T550	5,5	4	220	3	16,5	18,4	118	3440	0,72	77	-	1,15	5000	505	15,1	2,7	4 x 2
			380		9,9	11,2	67		0,74								
4OM-T750	7,5	5,5	220	3	21,9	25,1	137	3460	0,78	79	-	1,15	5000	589	19,8	2,7	4 x 2
			380		12,9	14,2	79	3450									
4OM-T1000	10	7,5	220	3	28,1	31,4	163	3440	0,79	81	-	1,15	5000	800,2	28,95	2,7	4 x 2
			380		16,9	18,9	94		0,80								



# 40M2W

50 Hz - 60 Hz

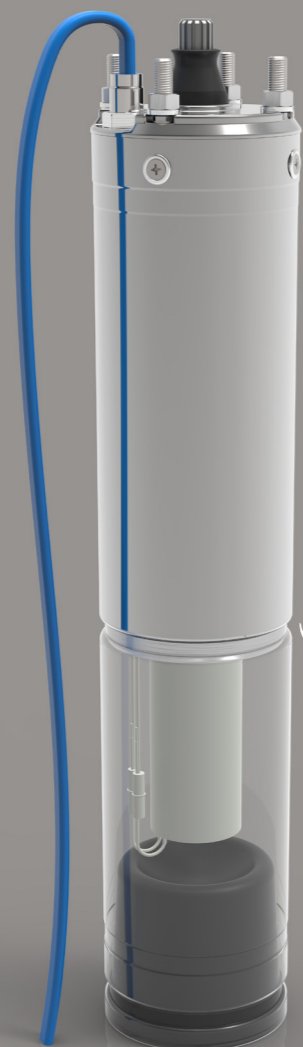

BUILT-IN CAPACITOR AND THERMAL PROTECTION

## TECHNICAL SPECIFICATIONS

REWINDABLE MOTORS

MOTOR/PUMP FLANGE  
4" NEMA STANDARD

POWERS  
Single-phase 50 Hz: from 0,75 to 1,5 Hp  
Single-phase 60 Hz: from 0,5 to 1,5 Hp

VOLTAGE  
Single-phase: 230 V / 50 Hz - 110;220 V / 60 Hz

THRUST LOAD  
2000 N

## VERSIONS UPON REQUEST

Different voltage  
Sic-Sic mechanical seal

## ACCESSORIES

refer to page 147 - 152 - 153

Cable lengths: 20 m or 30 m  
Sacrificial anode  
Control panels E.S.P.

## DIMENSIONS

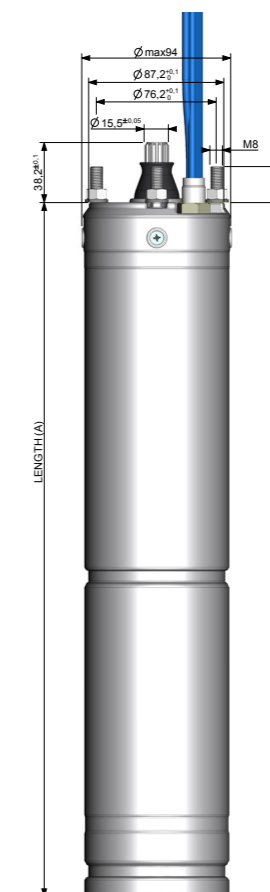

## CONSTRUCTION FEATURES

BUILT-IN CAPACITOR AND THERMAL PROTECTION, which allow an immediate use of the motor without needing to install an electrical control panel of protection.

For further features refer to 40M series (page 94).

## OPERATING LIMITS

DEGREE OF PROTECTION  
IP 68

INSULATION CLASS  
F

VOLTAGE TOLERANCE  
-10% / +10%

PUMPED LIQUID TEMPERATURE  
0°C - 35°C

MIN. COOLING FLOW  
0,1 m/s

MAX. STARTS / HOUR  
30

MOUNTING  
Vertical and/or horizontal

MAX. IMMERSION DEPTH  
200 m

## ELECTRICAL DATA 40M2W - 50Hz

Type	P <sub>2</sub> [Hp]	P <sub>2</sub> [kW]	Voltage [V]	Ph	I <sub>n</sub> [A]	I <sub>avv</sub> [A]	rpm	cos φ	η [%]	Capacitor [μF]	Thrust Load [N]	Length A [mm]	Weight [kg]	Cable Length [m]	Cable Section [mm <sup>2</sup> ]
40M2W-S075	0,75	0,55	230	1	4,7	16,5	2810	0,88	57	25	2000	417	7,90	1,5	3 x 1,5
40M2W-S100	1	0,75	230	1	5,9	18,9	2825	0,9	62	35	2000	442	9,10	1,5	3 x 1,5
40M2W-S150	1,5	1,1	230	1	8,3	26,2	2840	0,91	64	40	2000	482	10,70	1,5	3 x 1,5

## ELECTRICAL DATA 40M2W - 60Hz

Type	P <sub>2</sub> [Hp]	P <sub>2</sub> [kW]	Voltage [V]	Ph	I <sub>n</sub> [A]	I <sub>max</sub> [A]	I <sub>avv</sub> [A]	rpm	cos φ	η [%]	Capacitor [μF]	S.F.	Thrust Load [N]	Length A [mm]	Weight [kg]	Cable Length [m]	Cable Section [mm <sup>2</sup> ]
40M2W-S050	0,5	0,37	220	1	3,4	4,2	16	3450	0,92	54	20	1,6	2000	417	7,90	1,5	3 x 1,5
			110		6,8	9,9	29	3470	0,89	48	80						
40M2W-S075	0,75	0,55	220	1	4,7	6,8	20,2	3420	0,95	57	25	1,5	2000	417	7,90	1,5	3 x 1,5
			110		9,9	13,1	39	3435	0,84	53	80						
40M2W-S100	1	0,75	220	1	6,3	8,1	22,6	3435	0,95	58	35	1,4	2000	442	9,10	1,5	3 x 1,5
40M2W-S150	1,5	1,1	220	1	8,3	10,8	32	3455	0,98	64	40	1,3	2000	482	10,70	1,5	3 x 1,5

4" SINGLE-PHASE 2-WIRE OIL FILLED SUBMERSIBLE MOTORS

# 60M

50 Hz - 60 Hz

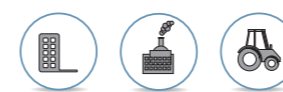

60M

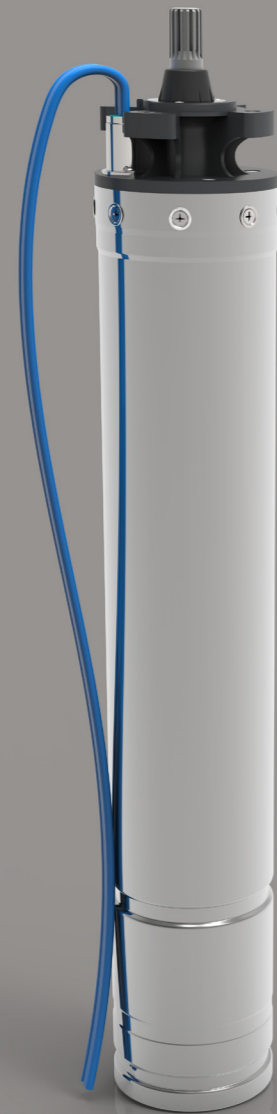

## TECHNICAL SPECIFICATIONS

### REWINDABLE MOTORS

**MOTOR/PUMP FLANGE**  
6" NEMA STANDARD

**POWERS**  
Three-phase: from 5,5 to 50 Hp

**VOLTAGE**  
Three-phase: 380;400;415 V / 50 Hz - 220;380;460 V / 60 Hz

**THRUST LOAD**  
From 5,5 to 20 Hp: 10000 N  
From 25 to 50 Hp: 20000 N

**CONNECTION**  
D.O.L.  
 $\lambda / \Delta$

## CONSTRUCTION FEATURES

**PARTS IN CONTACT WITH WATER** all made in AISI 304 stainless steel.

**EXTERNAL SLEEVE AND BOTTOM** made in AISI 304 stainless steel. More specifically, the sleeve is in 304L (Low Carbon) to avoid possible corrossions on the welding.

**UPPER BRACKET** made in cast iron with cataphoresis treatment in the standard version; 316 stainless steel available upon request. Sleeve clamping is ensured for the whole series by 8 inserts.

**DOUBLE OIL CHAMBER** interposed between the mechanical seal and motor's sand protection system thanks the bracket specifically designed on two levels. In this way a special mechanical seal protection is guaranteed.

**MECHANICAL SEAL** made in graphite/ceramic in the standard version; SIC-SIC version available upon request.

**BALL BEARINGS** duly oversized to ensure a long lasting motor.

**STATOR** specifically developed to achieve maximum electrical yield. Airtight sealed and immersed in selected mineral white and highly refined oil, suitable to be used in drinking water (F.D.A., Food and Drug Administration, approved).

**REMOVABLE POWER CABLE-CONNECTOR** to ensure a perfect sealing, also in the most critical conditions, and to aid maintenance operations. More specifically, the connector prevents oil from rising in the conductors up to the joint, thus enabling immersion at greater depths. The power cable complies with all major standards on the use in drinking water (KTW, ACS, WRAS).

**SHAFT** made in carbon-steel alloys in the rotor area, to foster electrical features. DUPLEX stainless steel projection. This steel combines excellent resistance to corrosion and high mechanical resistance, which is necessary where starting torque becomes really important.

**100% TESTED**, all motors are tested at the end of the line. Seal and electrical checks are carried out on all motors.

## VERSIONS UPON REQUEST

Different thrust loads  
Different voltage  
Sic-Sic mechanical seal  
Upper bracket made in 316 stainless steel

## OPERATING LIMITS

**DEGREE OF PROTECTION**  
IP 68

**INSULATION CLASS**  
F

**VOLTAGE TOLERANCE**  
-10% / +10%

**PUMPED LIQUID TEMPERATURE**  
0°C - 35°C

**MIN. COOLING FLOW**  
0,1 m/s

**MAX. STARTS / HOUR**  
30

**MOUNTING**  
Vertical (Horizontal up to 20 Hp)

**MAX. IMMERSION DEPTH**  
200 m

## ACCESSORIES *refer to page 147 - 153*

Different cable lengths  
Control panels *E.S.P.* (up to 15 Hp)

## DIMENSIONS

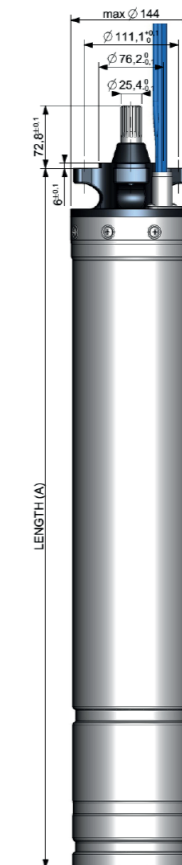

## 6" REWINDABLE OIL FILLED SUBMERSIBLE MOTORS

VERSIONS AVAILABLE



D.O.L. VERSION



λ/Δ VERSION



UPPER BRACKET MADE IN CAST IRON WITH CATHODOLYSIS TREATMENT



UPPER BRACKET MADE IN 316 STAINLESS STEEL

ELECTRICAL DATA 60M - 50Hz

Type	Voltage [V]	P <sub>2</sub> [Hp]	P <sub>2</sub> [kW]	Ph	I <sub>n</sub> [A]	I <sub>avv</sub> [A]	rpm	cos φ	η [%]	Thrust Load [N]	Length A [mm]	Weight [kg]	Cable Length [m]	Cable Section [mm <sup>2</sup> ]
60M-T0550	380	5,5	4	3	8,9	47	2830	0,85	76	10000	595	33	3	4 x 4
	400				9,1		2840	0,86	74					
	415				9,3		2850	0,86	72					
60M-T0750	380	7,5	5,5	3	12,9	66	2830	0,82	75	10000	625	35	3	4 x 4
	400				12,8		2840	0,84	74					
	415				12,7		2850	0,83	75					
60M-T1000	380	10	7,5	3	17,1	81	2840	0,80	79	10000	660	38	3	4 x 4
	400				16,8		2850	0,83	78					
	415				16,4		2860	0,85	78					
60M-T1250	380	12,5	9,2	3	21,8	98	2860	0,76	80	10000	700	40	3	4 x 4
	400				21,2		2880	0,77	81					
	415				19,7		2890	0,85	79					
60M-T1500	380	15	11	3	23,8	123	2840	0,79	84	10000	765	44	3	4 x 4
	400				22,9		2850	0,82	85					
	415				23,2		2870	0,83	82					
60M-T1750	380	17,5	13	3	27,8	141	2850	0,80	83	10000	820	51	3	4 x 4
	400				27,6		2860	0,80	84					
	415				27,3		2870	0,83	82					
60M-T2000	380	20	15	3	31,6	158	2830	0,85	81	10000	820	52	3	4 x 4
	400				30,7		2840	0,86	82					
	415				29,9		2860	0,89	80					
60M-T2500	380	25	18,5	3	39,0	231	2840	0,82	83	10000	883	62	3	4 x 4
	400				38,0		2850	0,84	84					
	415				38,5		2860	0,84	83					
60M-T3000	380	30	22	3	44,0	258	2830	0,88	82	10000	953	67	3	4 x 4
	400				45,5		2850	0,83	84					
	415				46,5		2860	0,82	83					
60M-T3500	380	35	26	3	53,5	296	2830	0,84	84	10000	1018	74	3	4 x 4
	400				52,0		2850	0,85	85					
	415				51,5		2860	0,86	85					
60M-T4000	380	40	30	3	63,5	348	2850	0,81	84	10000	1098	83	3	4 x 4
	400				61,5		2860	0,83	85					
	415				63,0		2870	0,83	83					
60M-T5000	380	50	37	3	78,0	396	2810	0,82	83	10000	1233	92	3	4 x 4
	400				76,0		2840	0,84	84					
	415				77,0		2850	0,85	82					

ELECTRICAL DATA 60M - 60Hz

Type	Voltage [V]	P <sub>2</sub> [Hp]	P <sub>2</sub> [kW]	Ph	I <sub>n</sub> [A]	I <sub>max</sub> [A]	rpm	cos φ	η [%]	Thrust Load [N]	Length A [mm]	Weight [kg]	Cable Length [m]	Cable Section [mm <sup>2</sup> ]
60M-T0550	220	5,5	4	3	16,1	16,9	3435	0,79	74	10000	595	33	3	4 x 4
	380				9,7	16,8	3435	0,81	75					
	460				7,9	9,1	3435	0,79	76					
60M-T0750	220	7,5	5,5	3	23,7	26,4	3440	0,81	77	10000	625	35	3	4 x 4
	380				13,2	15,3	3440	0,78	78					
	460				11,3	12,7	3440	0,79	79					
60M-T1000	220	10	7,5	3	28,4	32,9	3435	0,81	79	10000	660	38	3	4 x 4
	380				17,3	19,3	3435	0,84	79					
	460				14,7	16,6	3435	0,85	80					
60M-T1250	220	12,5	9,2	3	34,6	36,2	3455	0,80	80	10000	700	40	3	4 x 4
	380				19,9	22,1	3455	0,79	81					
	460				19,7	22,2	3455	0,79	82					
60M-T1500	220	15	11	3	38,4	46,7	3450	0,79	79	10000	765	44	3	4 x 4
	380				25,8	29,6	3450	0,81	80					
	460				21,2	24,3	3450	0,83	81					
60M-T2000	220	20	15	3	54,1	60,8	3435	0,77	80	10000	820	52	3	4 x 4
	380				33,8	37,2	3435	0,81	81					
	460				27,8	30,9	3435	0,80	82					
60M-T2500	220	25	18,5	3	66,5	75,5	3445	0,81	81	10000	883	62	3	4 x 4
	380				40,1	45,9	3445	0,78	82					
	460				35,7	38,5	3445	0,8	83					
60M-T3000	220	30	22	3	79,1	89,0	3450	0,76	81	10000	953	67	3	4 x 4
	380				46,2	53,8	3450	0,81	83					
	460				43,1	46,0	3450	0,82	84					
60M-T4000	380	40	30	3	65,1	74,2	3445	0,82	84	10000	1098	83	3	4 x 4
	460				55,2	61,2	3445	0,80	85					
	380				82,2	93,5	3440	0,83	83					
60M-T5000	380	50	37	3	74,3	77,0	3440	0,84	84	10000	1233	92	3	4 x 4
	460				74,3	77,0	3440	0,84	84					

# 4WWM

50 Hz - 60 Hz

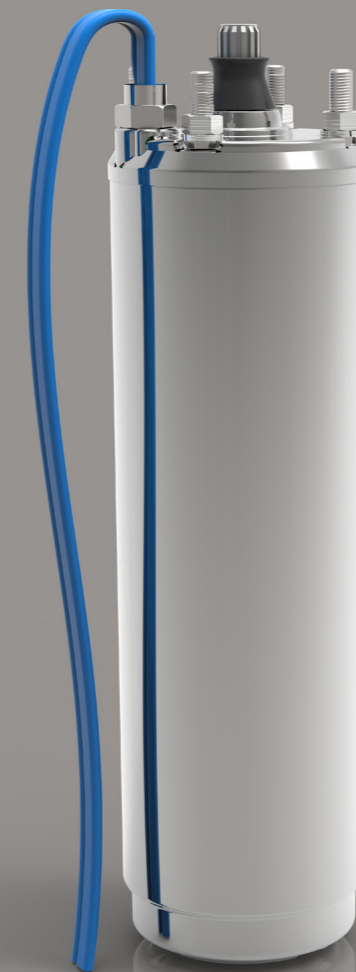

**Water filled  
submersible motors**



Made in Italy

**4" WATER COOLED  
SUBMERSIBLE MOTORS, CANNED TYPE**

TECHNICAL SPECIFICATIONS

**MOTORS WITH AIRTIGHT SEALED AND RESIN ENCAPSULATED STATOR**

**MOTOR/PUMP FLANGE**  
4" NEMA STANDARD

**POWERS**  
Single-phase: from 0,5 to 5 Hp  
Three-phase: from 0,5 to 10 Hp

**VOLTAGE**  
Single-phase:  
PSC type 230 V / 50 Hz  
3-wire 115;230 V / 60 Hz  
Three-phase:  
230;400 V / 50 Hz  
3-wire 230;380;460 V / 60 Hz

**THRUST LOAD**  
50 Hz from 0,5 to 1 Hp: 2000 N  
from 1,5 to 4 Hp: 3000 N  
from 4 to 10 Hp: 6500 N  
60 Hz from 0,5 to 0,75 Hp: 2000 N  
from 1 to 3 Hp: 3000 N  
from 5 to 10 Hp: 6500 N

CONSTRUCTION FEATURES

**PARTS IN CONTACT WITH WATER** all made in AISI 304 stainless steel which ensures resistance to corrosion even in the most extreme conditions of use. External sleeve made in AISI 304L (Low Carbon) for a greater resistance to corrosion.

**STATOR** with 24 slots, specifically developed to achieve maximum electrical performance. Airtight sealed and resin encapsulated. A solution which ensures excellent heat exchange and extremely high mechanical resistance with high pressure, something typical of very deep immersions.

**REMOVABLE POWER CABLE-CONNECTOR** to ensure a perfect sealing, also in the most critical conditions, and to aid maintenance operations. The power cable complies with all major standards on the use in drinking water (KTW, ACS, WRAS).

**FILLING LIQUID** is a mixture of water and propylene glycol to ensure adequate lubrication of the thrust bearing system and to lower the freezing point when stored in very cold places.

**RESTORE LIQUID VALVE** which allows water in to restore internal level.

**SHAFT** made in carbon-steel alloys in the rotor area, to foster electrical features. AISI 304 stainless steel projection. DUPLEX, a special type of stainless steel, replaces AISI 304 in motors bigger than 3 Hp. This steel combines excellent resistance to corrosion and high mechanical resistance, which is necessary where starting torque becomes really important.



**THRUST BEARING SYSTEM** Kingsbury-type with stainless steel thrust bearing runners oscillating on a self-aligning system. A specific runner lapping process makes this system extremely reliable and efficient.

**100% TESTED**, all motors are tested at the end of the line. Seal and electrical checks are carried out on all motors.

VERSIONS UPON REQUEST

Different thrust load  
Different voltage

OPERATING LIMITS

**DEGREE OF PROTECTION**  
IP 68

**INSULATION CLASS**  
F

**VOLTAGE TOLERANCE**  
-10% / +10%

**PUMPED LIQUID TEMPERATURE**  
0°C - 35°C

**MIN. COOLING FLOW**  
0,1 m/s

**MAX. STARTS / HOUR**  
30

**MOUNTING**  
Vertical and/or horizontal

**MAX. IMMERSION DEPTH**  
300 m

**SINGLE-PHASE VERSION**  
PSC type 50 Hz  
3-wire CSIR from 0,5 to 1 Hp 60 Hz  
3-wire CSCR from 1,5 to 5 Hp 60 Hz

ACCESSORIES refer to page 147 - 148 - 152 - 153

Different cable lengths  
Capacitors  
Control panels

DIMENSIONS

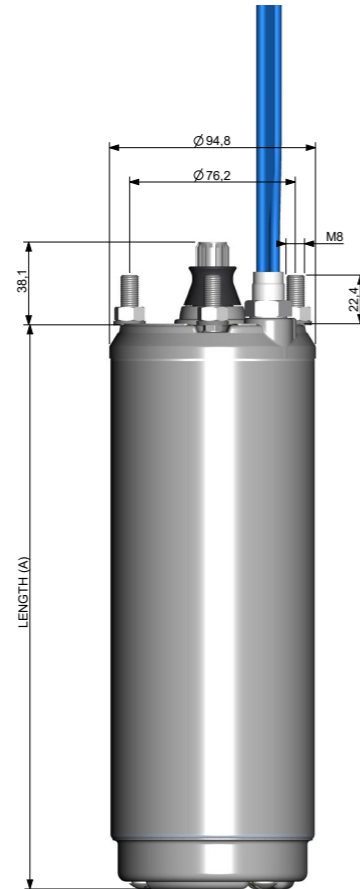

ELECTRICAL DATA 4WM - 50Hz

Type	P <sub>2</sub> [Hp]	P <sub>2</sub> [kW]	Voltage [V]	Ph	I <sub>n</sub> [A]	I <sub>avv</sub> [A]	rpm	cos φ	η [%]	Capacitor [μF]	Thrust Load [N]	Length A [mm]	Weight [kg]	Cable Length [m]	Cable Section [mm <sup>2</sup> ]
4WM-S050	0,5	0,37	230	1	3,2	13,4	2855	0,95	55	20	2000	260	7,8	1,7	4 x 1,5
4WM-S075	0,75	0,55	230	1	4,2	17,4	2850	0,96	60	25	2000	280	8,4	1,7	4 x 1,5
4WM-S100	1	0,75	230	1	5,8	23,3	2850	0,93	59	35	2000	306	9,2	1,7	4 x 1,5
4WM-S150	1,5	1,1	230	1	7,8	32,7	2845	0,97	67	40	3000	351	10,5	1,7	4 x 1,5
4WM-S200	2	1,5	230	1	10,4	42	2835	0,99	66	60	3000	386	11,6	1,7	4 x 1,5
4WM-S300	3	2,2	230	1	14,8	61,5	2830	0,98	68	70	3000	441	13,3	1,7	4 x 1,5
4WM-S500	5	3,7	230	1	21,8	102	2840	0,99	76	100+250/300	6500	654	27,8	2,7	4 x 2
4WM-T050	0,5	0,37	230/400	3	1,2/1,3	9,3/5,5	2860	0,64	63	-	2000	240	7,2	1,7	4 x 1,5
4WM-T075	0,75	0,55	230/400	3	2,8/1,6	12,5/7,4	2850	0,74	70	-	2000	260	7,8	1,7	4 x 1,5
4WM-T100	1	0,75	230/400	3	3,8/2,2	18,1/10,6	2855	0,69	72	-	2000	280	8,4	1,7	4 x 1,5
4WM-T150	1,5	1,1	230/400	3	5,3/3,1	27,3/16,1	2855	0,66	76	-	3000	306	9,2	1,7	4 x 1,5
4WM-T200	2	1,5	230/400	3	6,7/3,9	35,5/20,9	2845	0,73	76	-	3000	351	10,5	1,7	4 x 1,5
4WM-T300	3	2,2	230/400	3	9,2/5,4	50,8/29,9	2840	0,78	76	-	3000	386	11,6	1,7	4 x 1,5
4WM-T400	4	3	230/400	3	13/7,6	70,5/41,5	2855	0,77	76	-	3000/6500/3000/6500	441/484/441/484	19,8/20,5/19,8/20,5	1,7/2,7/1,7/2,7	4 x 1,5/4 x 2/4 x 1,5/4 x 2
4WM-T550	5,5	4	230/400	3	16,9/9,9	96/56,8	2840	0,82	77	-	6500	544	23,2	2,7	4 x 2
4WM-T750	7,5	5,5	230/400	3	21,6/12,7	132/77,3	2835	0,85	78	-	6500	654	27,8	2,7	4 x 2
4WM-T1000	10	7,5	400	3	17,2	99	2840	0,86	79	-	6500	764	32,5	2,7	4 x 2

ELECTRICAL DATA 4WM - 60Hz

Type	P <sub>2</sub> [Hp]	P <sub>2</sub> [kW]	Voltage [V]	S.F.	Ph	FULL LOAD AMPS		rpm	cos φ	η [%]	Capacitor [μF]		Thrust Load [N]	Length A [mm]	Weight [kg]	Cable Length [m]	Cable Section [mm <sup>2</sup> ]
						I <sub>n</sub> [A]	I <sub>MAX</sub> [A]				C <sub>run</sub>	C <sub>start</sub>					
Single-phase 3-wire CSIR																	
4WM-S050	0,5	0,37	115	1,6	1	9,3	12,4	3450	0,68	54	-	250-300	2000	280	8,4	1,7	4 x 1,5
4WM-S050	0,5	0,37	230	1,6	1	4,8	6,2	3450	0,68	54	-	59-71	2000	280	8,4	1,7	4 x 1,5
4WM-S075	0,75	0,55	115	1,5	1	12,2	15,8	3450	0,68	60	-	250-300	2000	306	9,2	1,7	4 x 1,5
4WM-S075	0,75	0,55	230	1,5	1	6,1	7,9	3450	0,68	60	-	86-103	2000	306	9,2	1,7	4 x 1,5
4WM-S100	1	0,75	230	1,4	1	8,2	10,1	3450	0,69	61	-	105-126	3000	326	9,8	1,7	4 x 1,5
Single-phase 3-wire CSCR																	
4WM-S150	1,5	1,1	230	1,3	1	9,8	11,1	3450	0,72	67	16	105-126	3000	371	11,1	1,7	4 x 1,5
4WM-S200	2	1,5	230	1,25	1	10,4	12,6	3450	0,8	68	20	105-126	3000	386	11,6	1,7	4 x 1,5
4WM-S300	3	2,2	230	1,15	1	14,1	15,9	3450	0,91	69	45	208-250	3000	441	13,3	1,7	4 x 1,5
4WM-S500	5	3,7	230	1,15	1	24,1	26,8	3450	0,87	72	80	270-324	6500	654	27,8	2,7	4 x 2
Three-phase 3-wire																	
4WM-T050	0,5	0,37	230	1,6	3	2,8	3,5	3450	0,5	61	-	-	2000	260	7,8	1,7	4 x 1,5
4WM-T050	0,5	0,37	380	1,6	3	1,5	1,9	3450	0,5	61	-	-	2000	260	7,8	1,7	4 x 1,5
4WM-T050	0,5	0,37	460	1,6	3	1,4	1,7	3450	0,5	61	-	-	2000	260	7,8	1,7	4 x 1,5
4WM-T075	0,75	0,55	230	1,5	3	3,6	4,2	3450	0,55	68	-	-	2000	280	8,4	1,7	4 x 1,5
4WM-T075	0,75	0,55	380	1,5	3	2	2,4	3450	0,55	68	-	-	2000	280	8,4	1,7	4 x 1,5
4WM-T075	0,75	0,55	460	1,5	3	1,6	2,2	3450	0,55	68	-	-	2000	280	8,4	1,7	4 x 1,5
4WM-T100	1	0,75	230	1,4	3	4,8	5,6	3450	0,56	71	-	-	3000	306	9,2	1,7	4 x 1,5
4WM-T100	1	0,75	380	1,4	3	2,8	3,2	3450	0,56	71	-	-	3000	306	9,2	1,7	4 x 1,5
4WM-T100	1	0,75	460	1,4	3	2,2	2,6	3450	0,56	71	-	-	3000	306	9,2	1,7	4 x 1,5
4WM-T150	1,5	1,1	230	1,3	3	5,4	6,8	3450	0,68	78	-	-	3000	326	9,8	1,7	4 x 1,5
4WM-T150	1,5	1,1	380	1,3	3	3,2	3,8	3450	0,68	78	-	-	3000	326	9,8	1,7	4 x 1,5
4WM-T150	1,5	1,1	460	1,3	3	3,1	3,7	3450	0,68	78	-	-	3000	326	9,8	1,7	4 x 1,5
4WM-T200	2	1,5	230	1,25	3	6,9	7,9	3450	0,73	78	-	-	3000	351	10,5	1,7	4 x 1,5
4WM-T200	2	1,5	380	1,25	3	3,9	4,4	3450	0,73	78	-	-	3000	351	10,5	1,7	4 x 1,5
4WM-T200	2	1,5	460	1,25	3	3,6	4,1	3450	0,73	78	-	-	3000	351	10,5	1,7	4 x 1,5
4WM-T300	3	2,2	230	1,15	3	9,8	11,2	3450	0,82	82	-	-	3000	386	11,6	1,7	4 x 1,5
4WM-T300	3	2,2	380	1,15	3	5,6	6	3450	0,82	82	-	-	3000	386	11,6	1,7	4 x 1,5
4WM-T300	3	2,2	460	1,15	3	5,2	5,8	3450	0,82	82	-	-	3000	386	11,6	1,7	4 x 1,5
4WM-T500	5	3,7	230	1,15	3	17,1	19,1	3450	0,82	76	-	-	6500	544	23,2	2,7	4 x 2
4WM-T500	5	3,7	380	1,15	3	9,8	10,4	3450	0,82	76	-	-	6500	544	23,2	2,7	4 x 2
4WM-T500	5	3,7	460	1,15	3	8,6	9,4	3450	0,82	76	-	-	6500	544	23,2	2,7	4 x 2
4WM-T550	5,5	4	230	1,15	3	17,4	19,3	3450	0,8	78	-	-	6500	544	23,2	2,7	4 x 2
4WM-T550	5,5	4	380	1,15	3	10,1	10,6	3450	0,8	78	-	-	6500	544	23,2	2,7	4 x 2
4WM-T550	5,5	4	460	1,15	3	9,1	9,7	3450	0,8	78	-	-	6500	544	23,2	2,7	4 x 2
4WM-T750	7,5	5,5	230	1,15	3	24,8	25,7	3450	0,78	79	-	-	6500	654	27,8	2,7	4 x 2
4WM-T750	7,5	5,5	380	1,15	3	13,4	14,9	3450	0,78	79	-	-	6500	654	27,8	2,7	4 x 2
4WM-T750	7,5	5,5	460	1,15	3	12,2	13,4	3450	0,78	79	-	-	6500	654	27,8	2,7	4 x 2
4WM-T1000	10	7,5	380	1,15	3	17,2	17,7	3450	0,77	80	-	-	6500	764	32,5	2,7	4 x 2
4WM-T1000	10	7,5	460	1,15	3	16,1	16,9	3450	0,77	80	-	-	6500	764	32,5	2,7	4 x 2



# 4WM2W

50 Hz - 60 Hz

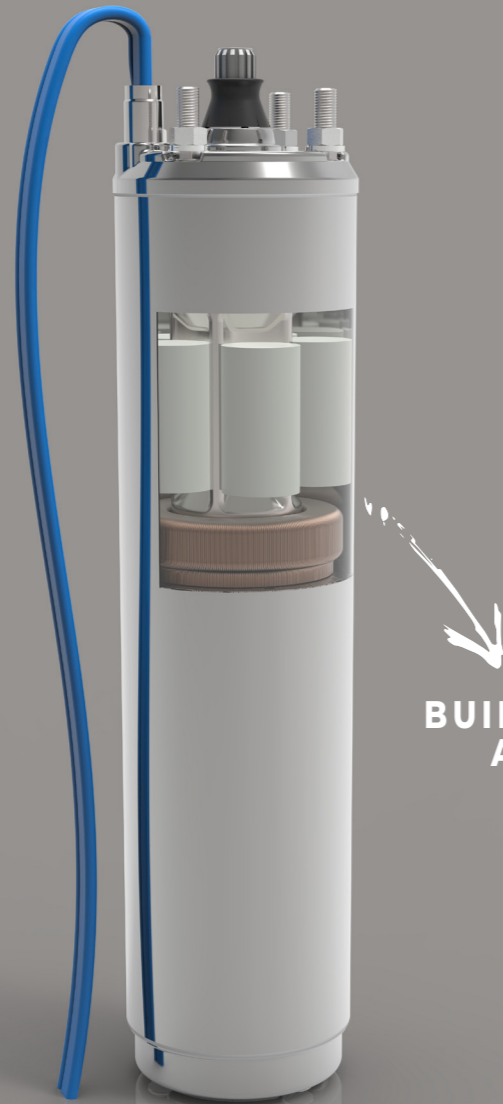

**BUILT-IN CAPACITOR AND THERMAL PROTECTION**

## TECHNICAL SPECIFICATIONS

**MOTORS WITH AIRTIGHT SEALED AND RESIN ENCAPSULATED STATOR**

**MOTOR/PUMP FLANGE**  
4" NEMA STANDARD

**POWERS**  
Single-phase: from 0,5 to 1,5 Hp

**VOLTAGE**  
Single-phase:  
2-wire PSC type 230 V / 50 Hz  
2-wire PSC type 115;230 V / 60 Hz

**THRUST LOAD**  
50 Hz from 0,5 to 1 Hp: 2000 N  
1,5 Hp: 3000 N  
60 Hz from 0,5 to 0,75 Hp: 2000 N  
from 1 to 1,5 Hp: 3000 N

## CONSTRUCTION FEATURES

**BUILT-IN CAPACITOR AND THERMAL PROTECTION**, which allow an immediate use of the motor without needing to install an electrical control panel of protection.

For further features refer to 4WM series (page 104).

## OPERATING LIMITS

**DEGREE OF PROTECTION**  
IP 68

**INSULATION CLASS**  
F

**VOLTAGE TOLERANCE**  
-10% / +10%

**PUMPED LIQUID TEMPERATURE**  
0°C – 35°C

**MIN. COOLING FLOW**  
0,1 m/s

**MAX. STARTS / HOUR**  
30

**MOUNTING**  
Vertical and/or horizontal

**MAX. IMMERSION DEPTH**  
300 m

**SINGLE-PHASE VERSION**  
2-wire PSC type from 0,5 to 1,5 Hp

## VERSIONS UPON REQUEST

Different voltage

## ACCESSORIES

refer to page 153

Cable lengths: 20 m or 30 m

## DIMENSIONS

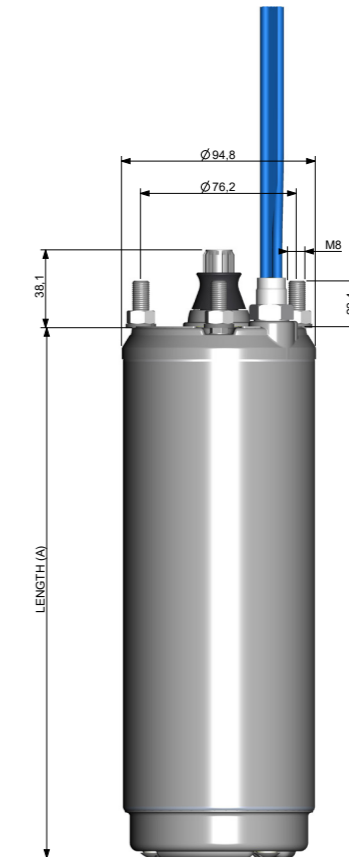

## ELECTRICAL DATA 4WM2W - 50Hz

Type	P <sub>2</sub> [Hp]	P <sub>2</sub> [kW]	Voltage [V]	Ph	I <sub>n</sub> [A]	I <sub>sw</sub> [A]	rpm	cos φ	η [%]	Capacitor [μF]	Thrust Load [N]	Length A [mm]	Weight [kg]	Cable Length [m]	Cable Section [mm <sup>2</sup> ]
Single-phase 2-wire PSC															
4WM2W-S050	0,5	0,37	230	1	3,2	13,4	2855	0,95	55	27	2000	337	10,1	1,5	3 x 1,5
4WM2W-S075	0,75	0,55	230	1	4,2	17,4	2850	0,96	60	27	2000	357	10,7	1,5	3 x 1,5
4WM2W-S100	1	0,75	230	1	5,8	23,3	2850	0,93	59	36	2000	377	11,3	1,5	3 x 1,5
4WM2W-S150	1,5	1,1	230	1	7,8	32,7	2845	0,97	67	36	3000	422	12,7	1,5	3 x 1,5

## ELECTRICAL DATA 4WM2W - 60Hz

Type	P <sub>2</sub> [Hp]	P <sub>2</sub> [kW]	Voltage [V]	S.F.	Ph	FULL LOAD AMPS		rpm	cos φ	η [%]	Capacitor [μF]	Thrust Load [N]	Length A [mm]	Weight [kg]	Cable Length [m]	Cable Section [mm <sup>2</sup> ]
						I <sub>n</sub> [A]	I <sub>MAX</sub> [A]									
Single-phase 2-wire PSC																
4WM2W-S050	0,5	0,37	115	1,6	1	8,4	10,5	3450	0,99	52	36	2000	357	10,7	1,5	3 x 1,5
4WM2W-S050	0,5	0,37	230	1,6	1	4	4,8	3450	0,99	54	27	2000	357	10,7	1,5	3 x 1,5
4WM2W-S075	0,75	0,55	115	1,5	1	9,8	10,4	3450	0,96	61	36	2000	377	11,3	1,5	3 x 1,5
4WM2W-S075	0,75	0,55	230	1,5	1	4,8	6	3450	0,96	61	27	2000	377	11,3	1,5	3 x 1,5
4WM2W-S100	1	0,75	230	1,4	1	6,2	7,6	3450	0,98	61	36	3000	397	11,9	1,5	3 x 1,5
4WM2W-S150	1,5	1,1	230	1,3	1	8,1	9,6	3450	0,98	62	36	3000	422	12,7	1,5	3 x 1,5

**4" SINGLE-PHASE 2-WIRE WATER COOLED SUBMERSIBLE MOTORS, CANNED TYPE**



# 4WMU

60 Hz



## TECHNICAL SPECIFICATIONS

**MOTORS WITH AIRTIGHT SEALED AND RESIN ENCAPSULATED STATOR**

**MOTOR/PUMP FLANGE**  
4" NEMA STANDARD

**POWERS**  
Single-phase: from 1/2 to 5 Hp  
Three-phase: from 1/2 to 10 Hp

**VOLTAGE**  
Single-phase: 3-wire 115;230 V / 60 Hz  
Three-phase: 3-wire 230;460 V / 60 Hz

**THRUST LOAD**  
From 1/2 to 3/4 Hp: 2000 N - 450 lbf  
From 1 to 3 Hp: 3000 N - 700 lbf  
From 5 to 10 Hp: 6500 N - 1500 lbf

## CONSTRUCTION FEATURES

**PARTS IN CONTACT WITH WATER** all made in AISI 304 stainless steel which ensures resistance to corrosion even in the most extreme conditions of use. External sleeve made in AISI 304L (Low Carbon) for even greater resistance to corrosion.

**STATOR** with 24 slots, specifically developed to achieve maximum electrical performance. Airtight sealed and resin encapsulated. A solution which ensures excellent heat exchange and extremely high mechanical resistance with high pressure, something typical of very deep immersions.

**REMOVABLE POWER CABLE-CONNECTOR** to ensure a perfect sealing, also in the most critical conditions, and to aid maintenance operations.

**FILLING LIQUID** composed of a mixture of water and propylene glycol (special antifreeze liquid) to ensure adequate lubrication of the thrust bearing system together with the ability to lower the freezing point when stored in very cold places.

**RESTORE LIQUID VALVE** which allows water in to restore internal level.

**SHAFT** made in carbon-steel alloys in the rotor area, to foster electrical features. AISI 304 stainless steel projection. DUPLEX, a special type of stainless steel, replaces AISI 304 in motors bigger than 3 Hp. This steel combines excellent resistance to corrosion and high mechanical resistance, which is necessary where starting torque becomes really important.



**THRUST BEARING SYSTEM** King-sbury-type with stainless steel thrust bearing runners oscillating on a self-aligning system. A specific runner lapping process makes this system extremely reliable and efficient.

**100% TESTED**, all motors are tested at the end of the line. Seal and electrical checks are carried out on all motors.

## VERSIONS UPON REQUEST

Different thrust load  
Different voltage

## OPERATING LIMITS

**DEGREE OF PROTECTION**  
IP 68

**INSULATION CLASS**  
F

**VOLTAGE TOLERANCE**  
-10% / +10%

**PUMPED LIQUID TEMPERATURE**  
0°C - 35°C / 32°F - 95°F

**MIN. COOLING FLOW**  
0,1 m/s - 0.33 ft/sec

**MAX. STARTS / HOUR**  
30

**MOUNTING**  
Vertical and/or horizontal

**MAX. IMMERSION DEPTH**  
300 m - 984.25 ft

**SINGLE-PHASE VERSION**  
3-wire CSIR from 1/2 to 1 Hp  
3-wire CSCR from 1.5 to 5 Hp

## ACCESSORIES *refer to page 149 - 152*

Different cable lengths  
Capacitors  
Control panels CU-BOX  
Lightning arrestor

## DIMENSIONS

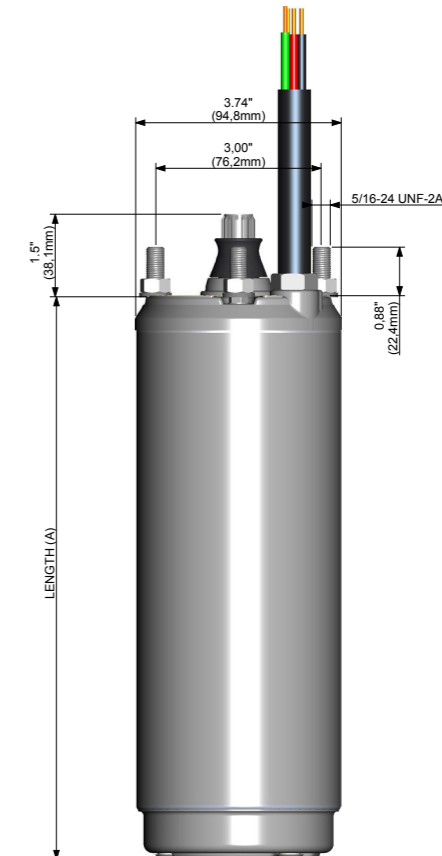

## 4" WATER COOLED SUBMERSIBLE MOTORS, CANNED TYPE

## ELECTRICAL DATA 4WMU - 60Hz

Type	P <sub>2</sub> [HP]	P <sub>2</sub> [kW]	Voltage [V]	S.F.	Ph	FULL LOAD AMPS	FULL S.F. AMPS	rpm	η [%]	Capacitor [μF]		Thrust Load		Length A		Weight		Cable Length		Cable Section [AWG]	
						I <sub>n</sub> [A]	I <sub>MAX</sub> [A]			C <sub>run</sub>	C <sub>start</sub>	[lbf]	[N]	[mm]	[in]	[kg]	[lb]	[m]	[ft]		
<b>Single-phase 3-wire CSIR</b>																					
4WMU-S050	1/2	0.37	115	1.6	1	11.3	14.6	3450	54	-	250-300	450	2000	280	11.0	8.4	18.5	1.7	5 1/2	4 x 14	
4WMU-S050	1/2	0.37	230	1.6	1	5.3	6.8	3450	54	-	59-71	450	2000	280	11.0	8.4	18.5	1.7	5 1/2	4 x 14	
4WMU-S075	3/4	0.55	115	1.5	1	14.6	18.2	3450	60	-	250-300	450	2000	306	12.0	9.2	20.3	1.7	5 1/2	4 x 14	
4WMU-S075	3/4	0.55	230	1.5	1	7.1	9	3450	60	-	86-103	450	2000	306	12.0	9.2	20.3	1.7	5 1/2	4 x 14	
4WMU-S100	1	0.75	230	1.4	1	8.6	11.1	3450	61	-	105-126	700	3000	326	12.8	9.8	21.6	1.7	5 1/2	4 x 14	
<b>Single-phase 3-wire CSCR</b>																					
4WMU-S150	1.5	1.1	230	1.3	1	9.7	11.4	3450	67	16	105-126	700	3000	371	14.6	11.1	24.5	1.7	5 1/2	4 x 14	
4WMU-S200	2	1.5	230	1.25	1	10.6	12.7	3450	68	20	105-126	700	3000	386	15.2	11.6	25.6	1.7	5 1/2	4 x 14	
4WMU-S300	3	2.2	230	1.15	1	14.1	16.1	3450	69	45	208-250	700	3000	441	17.4	13.3	29.3	1.7	5 1/2	4 x 14	
4WMU-S500	5	3.7	230	1.15	1	25.4	27.8	3450	72	80	270-324	1500	6500	654	25.7	27.8	61.3	2.7	8 3/4	4 x 14	
<b>Three-phase 3-wire</b>																					
4WMU-T050	1/2	0.37	230	1.6	3	3.2	3.7	3450	61	-	-	450	2000	260	10.2	7.8	17.2	1.7	5 1/2	4 x 14	
4WMU-T050	1/2	0.37	460	1.6	3	1.6	1.9	3450	61	-	-	450	2000	260	10.2	7.8	17.2	1.7	5 1/2	4 x 14	
4WMU-T075	3/4	0.55	230	1.5	3	4.3	4.7	3450	68	-	-	450	2000	280	11.0	8.4	18.5	1.7	5 1/2	4 x 14	
4WMU-T075	3/4	0.55	460	1.5	3	2.2	2.4	3450	68	-	-	450	2000	280	11.0	8.4	18.5	1.7	5 1/2	4 x 14	
4WMU-T100	1	0.75	230	1.4	3	5.3	5.8	3450	71	-	-	700	3000	306	12.0	9.2	20.3	1.7	5 1/2	4 x 14	
4WMU-T100	1	0.75	460	1.4	3	2.7	2.9	3450	71	-	-	700	3000	306	12.0	9.2	20.3	1.7	5 1/2	4 x 14	
4WMU-T150	1.5	1.1	230	1.3	3	5.7	6.4	3450	78	-	-	700	3000	326	12.8	9.8	21.6	1.7	5 1/2	4 x 14	
4WMU-T150	1.5	1.1	460	1.3	3	2.9	3.2	3450	78	-	-	700	3000	326	12.8	9.8	21.6	1.7	5 1/2	4 x 14	
4WMU-T200	2	1.5	230	1.25	3	7.6	8.5	3450	78	-	-	700	3000	351	13.8	10.5	23.1	1.7	5 1/2	4 x 14	
4WMU-T200	2	1.5	460	1.25	3	3.8	4.3	3450	78	-	-	700	3000	351	13.8	10.5	23.1	1.7	5 1/2	4 x 14	
4WMU-T300	3	2.2	230	1.15	3	10.7	11.6	3450	82	-	-	700	3000	386	15.2	11.6	25.6	1.7	5 1/2	4 x 14	
4WMU-T300	3	2.2	460	1.15	3	5.4	5.8	3450	82	-	-	700	3000	386	15.2	11.6	25.6	1.7	5 1/2	4 x 14	
4WMU-T500	5	3.7	230	1.15	3	16.4	18.1	3450	76	-	-	1500	6500	544	21.4	23.2	51.1	2.7	8 3/4	4 x 14	
4WMU-T500	5	3.7	460	1.15	3	8.2	9.1	3450	76	-	-	1500	6500	544	21.4	23.2	51.1	2.7	8 3/4	4 x 14	
4WMU-T550	5.5	4	230	1.15	3	17.2	18.9	3450	78	-	-	1500	6500	544	21.4	23.2	51.1	2.7	8 3/4	4 x 14	
4WMU-T550	5.5	4	460	1.15	3	8.6	9.5	3450	78	-	-	1500	6500	544	21.4	23.2	51.1	2.7	8 3/4	4 x 14	
4WMU-T750	7.5	5.5	230	1.15	3	23.6	25.8	3450	79	-	-	1500	6500	654	25.7	27.8	61.3	2.7	8 3/4	4 x 14	
4WMU-T750	7.5	5.5	460	1.15	3	11.8	12.9	3450	79	-	-	1500	6500	654	25.7	27.8	61.3	2.7	8 3/4	4 x 14	
4WMU-T1000	10	7.5	460	1.15	3	15.2	16.4	3450	80	-	-	1500	6500	764	30.1	32.5	71.6	2.7	8 3/4	4 x 14	





# 4WMU2W

60 Hz

## TECHNICAL SPECIFICATIONS

**MOTORS WITH AIRTIGHT SEALED AND RESIN ENCAPSULATED STATOR**

**MOTOR/PUMP FLANGE**  
4" NEMA STANDARD

**POWERS**  
Single-phase: from 1/2 to 1.5 Hp

**VOLTAGE**  
Single-phase: 2-wire PSC type 115;230 V / 60 Hz

**THRUST LOAD**  
From 1/2 to 3/4 Hp: 2000 N - 450 lbf  
From 1 to 1.5 Hp: 3000 N - 700 lbf

## VERSIONS UPON REQUEST

Different voltage

## ACCESSORIES

Different cable lengths  
Lightning arrestor

## DIMENSIONS

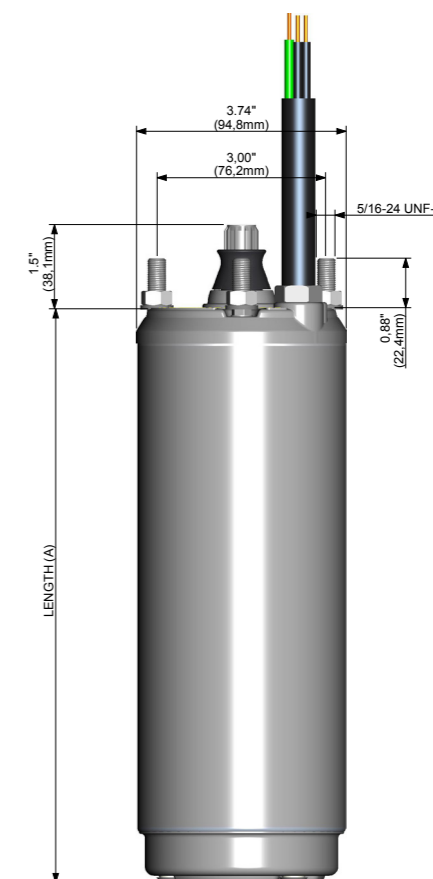

## CONSTRUCTION FEATURES

**BUILT-IN CAPACITOR AND THERMAL PROTECTION**, which allow an immediate use of the motor without needing to install an electrical control panel of protection.

For further features refer to 4WMU series (page 109).

## OPERATING LIMITS

**DEGREE OF PROTECTION**  
IP 68

**INSULATION CLASS**  
F

**VOLTAGE TOLERANCE**  
-10% / +10%

**PUMPED LIQUID TEMPERATURE**  
0°C - 35°C / 32°F - 95°F

**MIN. COOLING FLOW**  
0,1 m/s - 0.33 ft/sec

**MAX. STARTS / HOUR**  
30

**MOUNTING**  
Vertical and/or horizontal

**MAX. IMMERSION DEPTH**  
300 m - 984.25 ft

**SINGLE-PHASE VERSION**  
2-wire PSC type from 1/2 to 1.5 Hp

**BUILT-IN CAPACITOR AND THERMAL PROTECTION**

**4" SINGLE-PHASE 2-WIRE WATER COOLED SUBMERSIBLE MOTORS, CANNED TYPE**

## ELECTRICAL DATA 4WMU2W - 60Hz

Type	P <sub>2</sub> [HP]	P <sub>2</sub> [kW]	Voltage [V]	S.F.	Ph	FULL LOAD AMPS		rpm	η [%]	Capacitor [μF]	Thrust Load		Length A		Weight		Cable Length		Cable Section [AWG]	
						I <sub>n</sub> [A]	I <sub>MAX</sub> [A]				[lbf]	[N]	[mm]	[in]	[kg]	[lb]	[m]	[ft]		
Single-phase 2-wire PSC																				
4WMU2W-S050	1/2	0.37	115	1.6	1	8.4	10.5	3450	52	36	450	2000	357	14.1	10.7	23.6	1.7	5 1/2	4 x 14	
4WMU2W-S050	1/2	0.37	230	1.6	1	4	4.8	3450	54	27	450	2000	357	14.1	10.7	23.6	1.7	5 1/2	4 x 14	
4WMU2W-S075	3/4	0.55	115	1.5	1	9.8	10.4	3450	61	36	450	2000	377	14.8	11.3	24.9	1.7	5 1/2	4 x 14	
4WMU2W-S075	3/4	0.55	230	1.5	1	4.8	6	3450	61	27	450	2000	377	14.8	11.3	24.9	1.7	5 1/2	4 x 14	
4WMU2W-S100	1	0.75	230	1.4	1	6.2	7.6	3450	61	36	700	3000	397	15.6	11.9	26.2	1.7	5 1/2	4 x 14	
4WMU2W-S150	1.5	1.1	230	1.3	1	8.1	9.6	3450	62	36	700	3000	422	16.6	12.7	28.0	1.7	5 1/2	4 x 14	

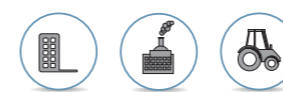

# 6WMI / 6WM

50 Hz - 60 Hz

**STANDARD VERSION**  
 COMPACT  
 EFFICIENT  
 ECONOMIC  
 INVERTER RESISTANT

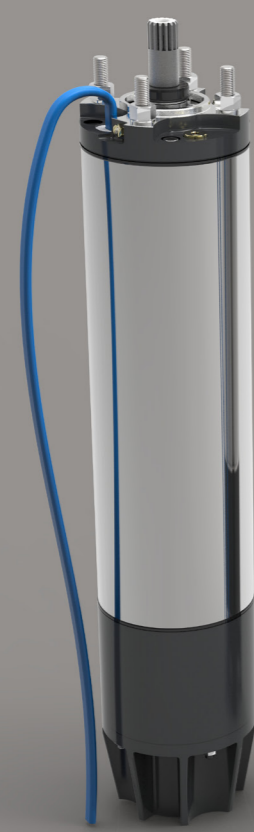

6WMI

**PE2+PA VERSION**  
 STRONG  
 EFFICIENT  
 INVERTER RESISTANT  
 SUITABLE FOR USE IN  
 HIGH TEMPERATURES

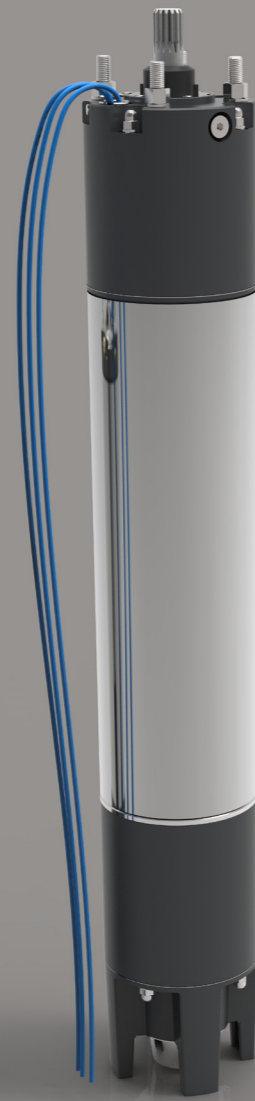

6WM

## 6" REWINDABLE WATER FILLED SUBMERSIBLE MOTORS

### TECHNICAL SPECIFICATIONS

**REWINDABLE MOTORS**  
 DESIGNED TO BE EASILY REPAIRABLE

**MOTOR/PUMP FLANGE**  
 6" NEMA STANDARD

**POWERS**  
 Three-phase: from 5,5 to 60 Hp

**VOLTAGE**  
 Three-phase: 230;400 V / 50 Hz - 220;380;460 V / 60Hz

**THRUST LOAD**  
 Refer to electrical data charts (page 116 - 117)

**COLLEGAMENTO**  
 D.O.L.  
 $\lambda/\Delta$

### CONSTRUCTION FEATURES

**STATOR** specifically developed to achieve maximum electrical yield. Covered by an AISI 304 stainless steel sleeve. Windings are asynchronous-type and are made of cooper wire with PPC (6WMI) insulation, or PE2+PA (6WM) insulation suggested for high temperatures and voltage surges. Both versions are suitable for use with inverter.

**POWER CABLE**, ensures perfect sealing in the most critical conditions. Of type:

- PVC (6WMI);
- EPR (6WM), which complies with all major standards on the use in drinking water (KTW, ACS, WRAS).

**FILLING LIQUID** composed of a mixture of water and propylene glycol to ensure adequate lubrication of the thrust bearing system together with the ability to lower the freezing point when stored in very cold places.

**UPPER AND LOWER BRACKET** made in GS400 spheroidal cast iron with cathoporesis treatment, which gives great resistance to water impacts and corrosion. 6WM version fully made in 316 stainless steel available upon request.

**MECHANICAL SEAL** made in SIC-SIC, silicon-silicon carbide.

**SHAFT** completely made in AISI 431 stainless steel, without welding. It is ground along the entire axis thus giving the rotor such a concentricity to ensure perfect linearity. A shaft free from vibration is obtained thanks to balancing. Led by wear-resistant graphite bushing bearings. The 6WM version fully made in 316 stainless steel is equipped with shaft projection made in DUPLEX.

**THRUST BEARING SYSTEM** bidirectional Michell-type, with pads in treated steel and supported by a disk in resin compound fibres and self-lubricating additives, totally ecological.

**100% TESTED**, all motors are tested at the end of the line.

### VERSIONS UPON REQUEST

Different thrust load  
 Different voltage  
 PT100 temperature sensor  
 Motor fully made in 316 stainless steel (only for 6WM version)

### OPERATING LIMITS

**DEGREE OF PROTECTION**  
 IP 68

**INSULATION CLASS**  
 PPC (6WMI): Y  
 PE2 + PA (6WM): A

**VOLTAGE TOLERANCE**  
 -10% / +10%

**PUMPED LIQUID TEMPERATURE**  
 PPC (6WMI): 0°C – 35°C  
 PE2 + PA (6WM): 0°C – 60°C

**MIN. COOLING FLOW**  
 0,1 m/s

**MAX. STARTS / HOUR**  
 10

**MOUNTING**  
 Vertical (Horizontal up to 20 Hp)

**MAX. IMMERSION DEPTH**  
 350 m

### ACCESSORIES *refer to page 147*

Different cable lengths  
 Control panels *E.S.P.* (up to 15 Hp)  
 PT100 temperature sensor

### DIMENSIONS

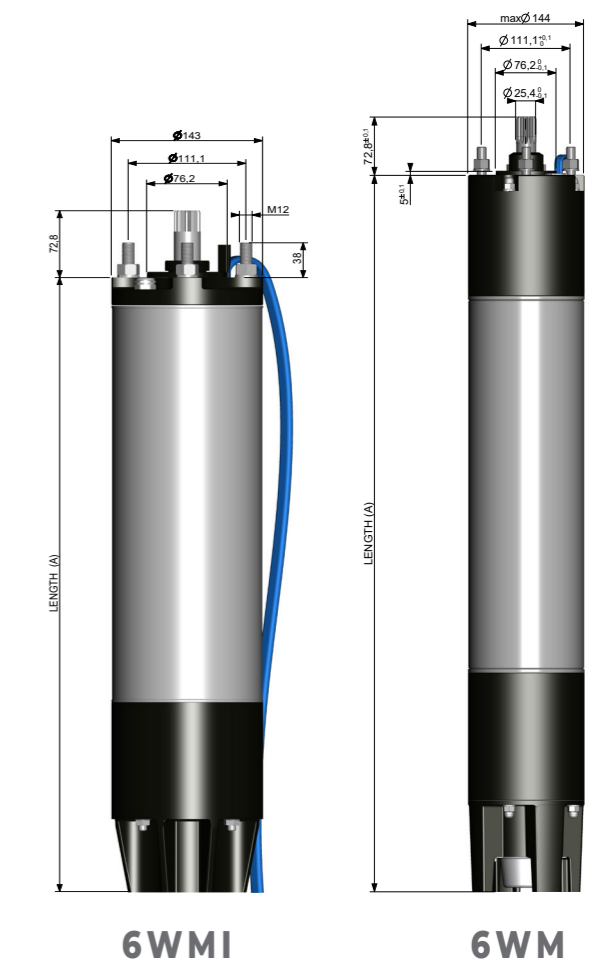

6WMI

6WM

**ELECTRICAL DATA 6WMI - 50Hz**

Type	Voltage [V]	P <sub>2</sub> [Hp]	P <sub>2</sub> [kW]	Ph	I <sub>n</sub> [A]	I <sub>av</sub> [A]	rpm	cos φ	η [%]	Thrust Load [N]	Length A [mm]	Weight [kg]	Cable Length [m]	Cable Section [mm <sup>2</sup> ]
6WMI-T0550	230	5,5	4	3	17,6	61,6	2885	0,80	74,7		690	42		
	380				10,2	35,7								
	400				10,3	36,05								
6WMI-T0750	230	7,5	5,5	3	23,5	94	2880	0,73	77,5	18.000	735	46,2		
	380				13,6	54,4								
	400				13,7	54,8								
6WMI-T1000	230	10	7,5	3	30,6	156,06	2875	0,82	78,6		780	51,2		2,5 x3
	380				17,7	90,27								
	400				17,9	91,29								
6WMI-T1250	230	12,5	9,2	3	37,0	185	2875	0,82	79,8		810	54,6		
	380				21,4	107								
	400				21,5	105,35								
6WMI-T1500	230	15	11	3	43,7	235,98	2870	0,82	80,7		840	56,8	3,5	
	380				25,3	136,62								
	400				25,6	138,24								
6WMI-T2000	230	20	15	3	59,6	298	2870	0,83	80,1	25.000	930	67,2		
	380				34,5	172,5								
	400				34,9	174,5								
6WMI-T2500	230	25	18,5	3	73,6	345,92	2870	0,81	81,8		1015	76		4 x 3
	380				42,6	200,22								
	400				43,5	204,45								
6WMI-T3000	230	30	22	3	86,4	432	2860	0,82	81,4		1060	80,9		6 x 3
	380				50,0	250								
	400				50,3	251,5								
6WMI-T3500	380	35	26	3	58,6	281,28	2860	0,81	83,2	28.000	1165	91,6		
	400				59,2	284,16								
	400				59,2	284,16								
6WMI-T4000	380	40	30	3	68,8	392,16	2870	0,80	83,3		1275	103	4,5	10 x 3
	400				69,7	397,29								
	400				69,7	397,29								
6WMI-T5000	380	50	37	3	84,5	507	2860	0,81	82,1		1365	113		
	400				85,2	511,2								
	400				85,2	511,2								

**ELECTRICAL DATA 6WM - 50Hz**

Type	Voltage [V]	P <sub>2</sub> [Hp]	P <sub>2</sub> [kW]	Ph	I <sub>n</sub> [A]	I <sub>av</sub> [A]	rpm	cos φ	η [%]	Thrust Load [N]	Length A [mm]	Weight [kg]	Cable Length [m]	Cable Section [mm <sup>2</sup> ]
6WM-T0550	230	5,5	4	3	16,8	59	2852	0,8	74,8		597	44		4 x 3
	380				10	35								
	400				9,9	35								
6WM-T0750	230	7,5	5,5	3	23	81	2839	0,8	76,7		627	46		4 x 3
	380				13,2	47								
	400				13	46								
6WM-T1000	230	10	7,5	3	30	105	2837	0,81	78,4		667	50		4 x 3
	380				17,4	61								
	400				17	60								
6WM-T1250	230	12,5	9,2	3	36	126	2862	0,82	79,1	25.000	697	54		4 x 3
	380				21	74								
	400				20	74								
6WM-T1500	230	15	11	3	41	144	2841	0,84	80,8		767	61	3,5	6 x 3
	380				25	88								
	400				24	84								
6WM-T2000	230	20	15	3	56	196	2836	0,83	81,6		827	68		10 x 3
	380				34	116								
	400				33	116								
6WM-T2500	230	25	18,5	3	69	242	2853	0,83	81,9	35.000	897	75		6 x 3
	380				41	147								
	400				40	140								
6WM-T3000	230	30	22	3	81	284	2868	0,82	83,5		967	82		10 x 3
	380				48	168								
	400				47	165								
6WM-T3500	380	35	26	3	56	196	2840	0,85	83		1027	89		6 x 3
	400				54	189								
	400				54	189								
6WM-T4000	380	40	30	3	64	224	2847	0,84	84,2		1167	103		10 x 3
	400				62	217								
	400				62	217								
6WM-T5000	380	50	37	3	80	280	2844	0,83	82,9	45.000	1297	116	4,5	10 x 3
	400				79	277								
	400				79	277								
6WM-T6000	380	60	45	3	100	350	2804	0,85	80,2		1400	121		10 x 3
	400				98	343								
	400				98	343								

**ELECTRICAL DATA 6WMI - 60Hz**

Type	Voltage [V]	P <sub>2</sub> [Hp]	P <sub>2</sub> [kW]	Ph	S.F.	I <sub>n</sub> [A]	I <sub>max</sub> [A]	I <sub>av</sub> [A]	rpm	cos φ	η [%]	Thrust Load [N]	Length A [mm]	Weight [kg]	Cable Length [m]	Cable Section [mm <sup>2</sup> ]
6WMI-T0550	220	5,5	4	3	1,15	18,9	20,7	75,6	3495	0,76	73,9		690	42		
	380					10,9	12									
	460					9	9,9									
6WMI-T0750	220	7,5	5,5	3	1,15	24,7	27,6	113,62	3490	0,75	78	18.000	735	46,2		
	380					14,3	16									
	460					11,8	13,2									
6WMI-T1000	220	10	7,5	3	1,15	32,2	35,6	164,22	3490	0,77	79,4		780	51,2		2,5 x3
	380					18,7	20,6									
	460					15,4	17									
6WMI-T1250	220	12,5	9,2	3	1,15	38,5	43,1	221,38	3480	0,79	80,5		810	54,6		
	380					22,3	25									
	460					18,4	20,6									
6WMI-T1500	220	15	11	3	1,15	45,2	51,5	280,24	3480	0,79	81,4	25.000	840	56,8	3,5	
	380					26,2	29,8									
	460					21,6	24,6									
6WMI-T2000	220	20	15	3	1,15	61,9	69,9	355,93	3480	0,79	80,5		930	67,2		4 x 3
	380					35,9	40,5									
	460					29,6	33,4									
6WMI-T2500	220	25	18,5	3	1,15	77,4	86,8	417,96	3475	0,76	82,6		1015	76		
	380					44,8	50,3									
	460					37	41,5									
6WMI-T3000	220	30	22	3	1,15	90,4	100,8	519,8	3470	0,79	81,4	28.000	1060	80,9		6 x 3
	380					52,3	58,4									
	460					43,2	48,2									
6WMI-T4000	380	40	30	3	1,15	72,2	80,3	472,91	3475	0,76	83,7		1275	113	4,5	10 x 3
	460					59,6	66,3									
	460					59,6	66,3									
6WMI-T5000	380	50	37	3	1,15	88,5	99,4	610,65	3465	0,77	82,5		1365	113		
	460					73,1	82,1									
	460					73,1	82,1									

**ELECTRICAL DATA 6WM - 60Hz**

Type	Voltage [V]	P <sub>2</sub> [Hp]	P <sub>2</sub> [kW]	Ph	S.F.	I <sub>n</sub> [A]	I <sub>max</sub> [A]	I <sub>av</sub> [A]	rpm	cos φ	η [%]	Thrust Load [N]	Length A [mm]	Weight [kg]	Cable Length [m]	Cable Section [mm <sup>2</sup> ]
6WM-T0550	220	5,5	4	3	1,15	17,5	19,3	62	3452	0,8	74,8		597	44		4 x 3
	380					10,2	11,2									
	460					8,9	9,8									
6WM-T0750	220	7,5	5,5	3	1,15	24	26,4	84	3439	0,8	76,7		627	46		4 x 3
	380					13,6	15									
	460					12,2	13,4									
6WM-T1000	220	10	7,5	3	1,15	31	34,1	109	3437	0,76	78,4		667	50		4 x 3
	380					17,9	19,7									
	460					14,8	16,3									
6WM-T1250	220	12,5	9,2	3	1,15	38	41,8	133	3462	0,77	79,1	25.000	697	54		4 x 3
	380					22	24,2									
	460					17,8	19,6									
6WM-T1500	220	15	11	3	1,15	43	47,3	151	3441	0,8	80,8		767	61	3,5	6 x 3
	380					25	27,5									
	460					21	23,1									
6WM-T2000	220	20	15	3	1,15	59	64,9	207	3436	0,77	81,6		827	68		10 x 3
	380					34	37,4									
	460					28	30,8									
6WM-T2500	220	25	18,5	3	1,15	72	79,2	252	3453	0,78	81,9	35.000	897	75		6 x 3
	380					42	46,2									
	460					25	27,5									
6WM-T3000	220	30	22	3	1,15	85	93,5	298	3468	0,75	83,5		967	82		10 x 3
	380					49	53,9									
	460					41	45,1									
6WM-T4000	380	40	30	3	1,15	66	72,6	231	3460	0,77	85		1167	103		10 x 3
	460					54	59,4									
	460					54	59,4									
6WM-T5000	380	50	37	3	1,15	84	92,4	294	3456	0,75	83,5	45.000	1297	116	4,5	10 x 3
	460					69	75,9									
	460					69										

# 6WMI / 6WM

## VERSIONS AVAILABLE



**6WMI: D.O.L. VERSION**



**6WMI:  $\lambda/\Delta$  VERSION**

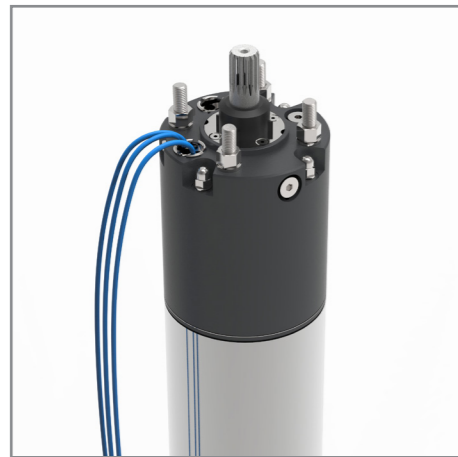

**6WM: D.O.L. VERSION**



**6WM:  $\lambda/\Delta$  VERSION**



**6WM: FULLY MADE IN 316 STAINLESS STEEL**

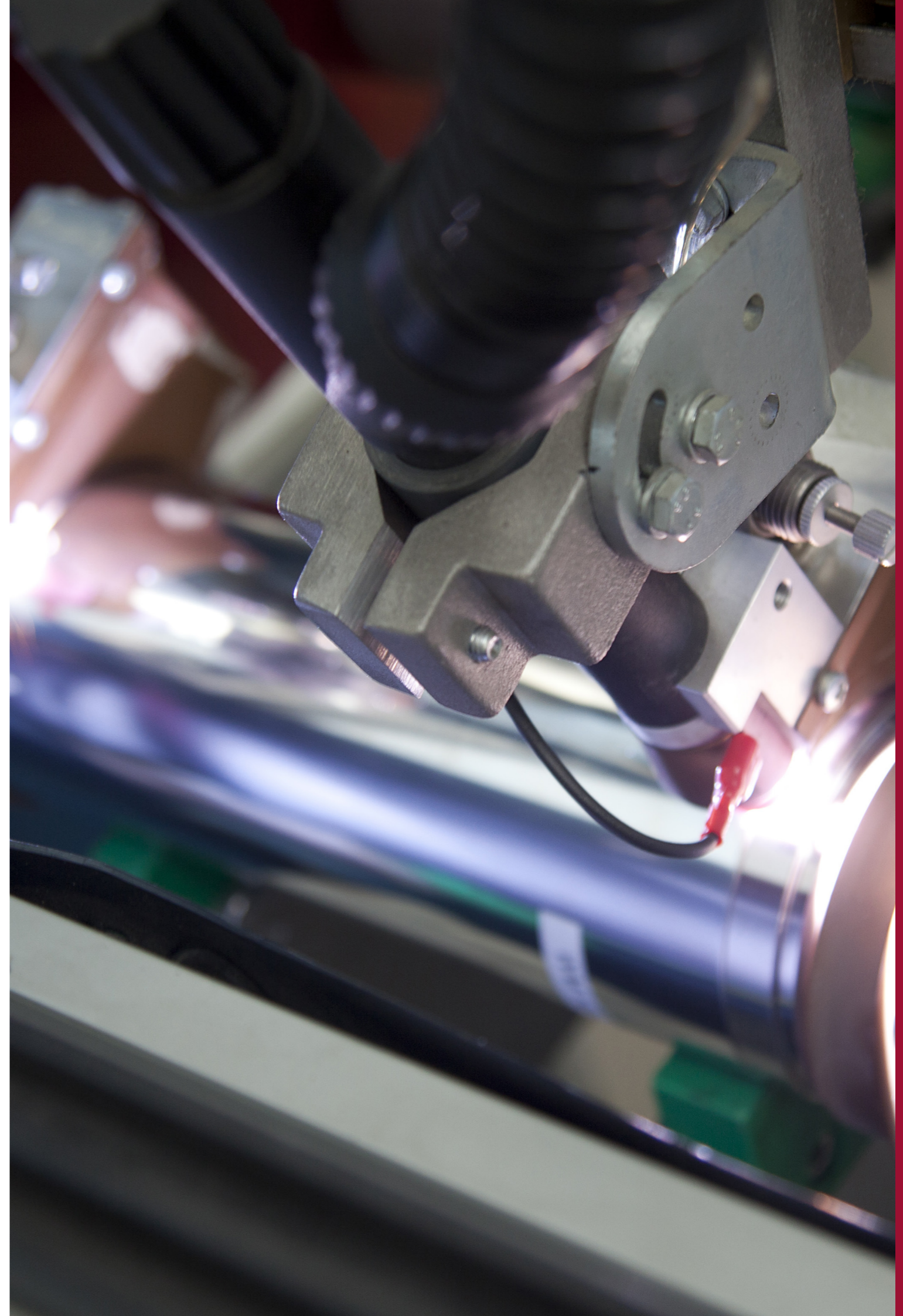

# 8WM

50 Hz - 60 Hz

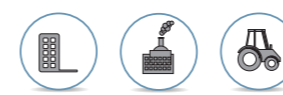

8WM

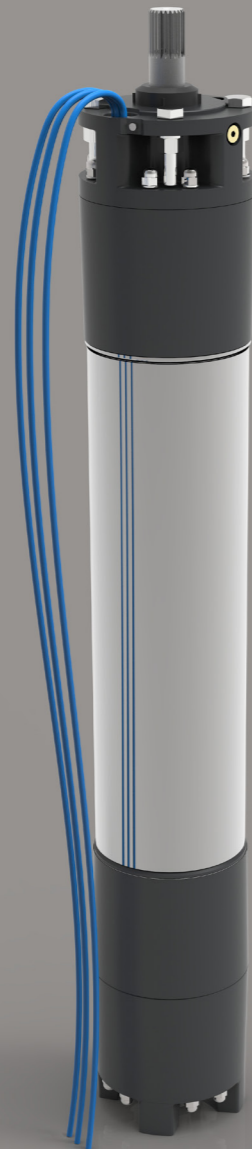

## TECHNICAL SPECIFICATIONS

**REWINDABLE MOTORS**  
DESIGNED TO BE EASILY REPAIRABLE

**MOTOR/PUMP FLANGE**  
8" NEMA STANDARD

**POWERS**  
Three-phase: from 30 to 150 Hp

**VOLTAGE**  
Three-phase: 230;380;400;415;500 V / 50 Hz  
220;380;440;460;575 v / 60 Hz

**THRUST LOAD**  
From 30 to 60 Hp: 50000 N  
From 70 to 85 Hp: 60000 N  
From 90 to 150 Hp: 70000 N

**COLLEGAMENTO**  
D.O.L.  
λ/Δ

## CONSTRUCTION FEATURES

**STATOR** specifically developed to achieve maximum electrical yield. Covered by an AISI 304 stainless steel sleeve. Windings are asynchronous-type and are made of cooper wire with PVC insulation, or copper wire with PE2+PA insulation, which is "inverter resistant" and suggested for high temperatures and voltage surges.

**POWER CABLE EPR-TYPE**, which ensures perfect sealing in the most critical conditions. It complies with all major standards on the use in drinking water (ACS, WRAS).

**FILLING LIQUID** composed of a mixture of water and propylene glycol to ensure adequate lubrication of the thrust bearing system together with the ability to lower the freezing point when stored in very cold places.

**UPPER AND LOWER BRACKET** made in GS400 spheroidal cast iron with cataphoresis treatment, which gives great resistance to water impacts and corrosion. Version fully made in 316 stainless steel available upon request.

**MECHANICAL SEAL** made in SIC-SIC, silicon-silicon carbide.

**SHAFT** completely made in AISI 431 stainless steel, without welding. It is ground along the entire axis thus giving the rotor such a concentricity to ensure perfect linearity. A shaft free from vibration is obtained thanks to balancing. Led by wear-resistant graphite bushing bearings. The 8WM version fully made in 316 stainless steel is equipped with shaft projection made in DUPLEX.

**THRUST BEARING SYSTEM** bidirectional Michell-type, with pads in treated steel and supported by a disk in resin compound fibres and self-lubricating additives, totally ecological.

**100% TESTED**, all motors are tested at the end of the line.

## VERSIONS UPON REQUEST

Different thrust load  
Different voltage  
PT100 temperature sensor  
PVC o PE2 + PA insulation windings  
Fully made in 316 stainless steel

## OPERATING LIMITS

**DEGREE OF PROTECTION**  
IP 68

**INSULATION CLASS**  
PVC: Y  
PE2 + PA: A

**VOLTAGE TOLERANCE**  
-10% / +10%

**PUMPED LIQUID TEMPERATURE**  
PVC: 0°C – 35°C  
PE2 + PA: 0°C – 60°C

**MIN. COOLING FLOW**  
0,1 m/s

**MAX. STARTS / HOUR**  
10

**MOUNTING**  
Vertical

**MAX. IMMERSION DEPTH**  
350 m

## ACCESSORIES

Different cable lengths  
PT100 temperature sensor

## DIMENSIONS

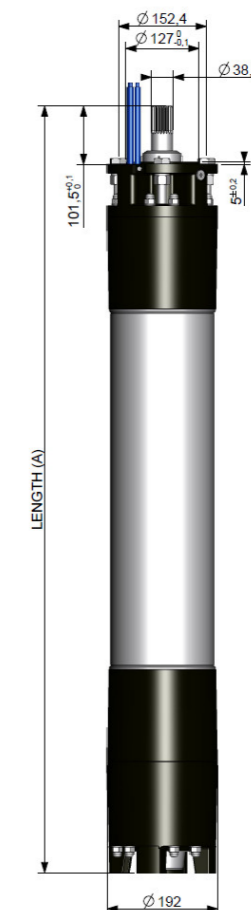

## 8" REWINDABLE WATER FILLED SUBMERSIBLE MOTORS

### ELECTRICAL DATA 8WM - 50Hz

Type	Voltage [V]	P <sub>2</sub> [Hp]	P <sub>2</sub> [kW]	Ph	I <sub>n</sub> [A]	I <sub>avv</sub> [A]	rpm	cos φ	η [%]	Thrust Load [N]	Length A [mm]	Weight [kg]	Cable Length [m]	Cable Section [mm <sup>2</sup> ]
8WM-T0300	230	30	22	3	82	328	2901	0,83	81,5	50.000	978,5	132		10 x 3
	380				48	192	2892	0,84	81					
	400				47	188	2901	0,83	81,5					
	415				46	184	2911	0,81	81,8					
	500				38	152	2892	0,84	81					
8WM-T0400	230	40	30	3	106	424	2886	0,85	83,9	50.000	1048,5	138		16 x 3
	380				63	252	2876	0,86	82,9					10 x 3
	400				61	244	2886	0,85	83,9					
	415				59	236	2898	0,84	84,4					
	500				49	196	2876	0,86	82,9					
8WM-T0500	230	50	37	3	131	524	2890	0,84	84,8	50.000	1118,5	153		25 x 3
	380				77	308	2881	0,85	84,4					16 x 3
	400				76	304	2890	0,84	84,8					
	415				74	396	2930	0,82	85,1					
	500				60	240	2881	0,85	84,4					
8WM-T0600	230	60	45	3	157	628	2900	0,84	86	50.000	1228,5	171		25 x 3
	380				93	372	2888	0,85	85,1					16 x 3
	400				91	364	2900	0,84	86					
	415				89	356	2909	0,81	86,1					
	500				72	288	2888	0,85	85,1					
8WM-T0700	230	70	51	3	178	712	2879	0,85	84,9	60.000	1228,5	172	3,5	25 x 3
	380				105	420	2869	0,86	84,1					16 x 3
	400				103	412	2879	0,85	84,9					
	415				100	400	2892	0,83	85,1					
	500				82	328	2869	0,86	84,1					
8WM-T0750	230	75	55	3	188	752	2890	0,85	86,7	60.000	1348,5	184		25 x 3
	380				110	440	2881	0,86	86,5					16 x 3
	400				107	428	2890	0,85	86,7					
	415				105	420	2902	0,84	87,1					
	500				86	344	2881	0,86	86,5					
8WM-T0800	380	80	59	3	120	480	2888	0,85	86,2	60.000	1348,5	184		16 x 3
	400				116	464	2898	0,83	87,5					
	415				115	460	2909	0,81	87,4					
	500				93	372	2888	0,85	86,2					
	8WM-T0850				380	85	62	3	123					
400		120	480	2892	0,84				88,6					
415		118	472	2906	0,82				88,8					
500		96	384	2885	0,85				87,8					
8WM-T0900		380	90	66	3				133	532	2873	0,85	86,2	60.000
	400	129				516	2883	0,84	87,1					
	415	126				504	2896	0,83	87,4					
	500	104				416	2873	0,85	86,2					
	8WM-T1000	380				100	75	3	151	604	2882	0,82	86,4	
400		146	584	2890	0,81				86,9					
415		142	568	2903	0,8				87,4					
500		117	468	2882	0,82				86,4					
8WM-T1250		380	125	92	3				186	744	2887	0,78	87,6	70.000
	400	181				724	2900	0,77	88,5					
	415	180				720	2907	0,75	88,4					
	500	145				580	2887	0,78	87,6					
	8WM-T1500	380				150	110	3	228	912	2890	0,75	86	
400		226	904	2899	0,74				86,3					
415		227	908	2911	0,7				86,3					
500		178	712	2890	0,75				86					

### ELECTRICAL DATA 8WM - 60Hz

Type	Voltage [V]	P <sub>2</sub> [Hp]	P <sub>2</sub> [kW]	Ph	I <sub>n</sub> [A]	I <sub>max</sub> [A]	I <sub>avv</sub> [A]	rpm	cos φ	η [%]	Thrust Load [N]	Length A [mm]	Weight [kg]	Cable Length [m]	Cable Section [mm <sup>2</sup> ]
8WM-T0300	220	30	22	3	85	93,5	340	3501	0,83	81,5	50.000	978,5	132		10 x 3
	380				50	55	200	3501	0,83	81,5					
	440				43	47,3	172	3492	0,84	81					
	460				41	45,1	164	3501	0,83	81,5					
	575				33	36,3	132	3501	0,83	81,5					
8WM-T0400	220	40	30	3	111	122,1	444	3486	0,85	83,9	50.000	1048,5	138		16 x 3
	380				64	70,4	256	3486	0,85	83,9					10 x 3
	440				56	61,6	224	3476	0,86	82,9					
	460				53	58,3	212	3486	0,85	83,9					
	575				43	47,3	172	3486	0,85	83,9					
8WM-T0500	220	50	37	3	164	180,4	656	3490	0,84	84,8	50.000	1118,5	153		25 x 3
	380				79	86,9	316	3490	0,84	84,8					16 x 3
	440				68	74,8	272	3481	0,85	84,4					
	460				66	72,6	264	3490	0,84	84,8					
	575				53	58,3	212	3490	0,84	84,8					
8WM-T0600	220	60	45	3	164	180,4	656	3500	0,84	86	60.000	1228,5	171		25 x 3
	380				95	104,5	380	3500	0,84	86					16 x 3
	440				82	90,2	328	3488	0,85	85,1					
	460				79	86,9	316	3500	0,84	86					
	575				63	69,3	252	3500	0,84	86					
8WM-T0700	220	70	51	3	186	204,6	744	3479	0,85	84,9	60.000	1228,5	172	3,5	25 x 3
	380				108	118,8	432	3479	0,85	84,9					16 x 3
	440				93	102,3	372	3469	0,86	84,1					
	460				89	97,9	356	3479	0,85	84,9					
	575				71	78,1	284	3479	0,85	84,9					
8WM-T0750	220	75	55	3	196	215,6	784	3490	0,85	86,7	60.000	1348,5	184		25 x 3
	380				114	125,4	456	3490	0,85	86,7					16 x 3
	440				97	106,7	388	3481	0,86	86,5					
	460				94	103,4	376	3490	0,85	86,7					
	575				75	82,5	300	3490	0,85	86,7					
8WM-T0800	380	80	59	3	124	136,4	496	3498	0,83	87,5	60.000	1348,5	184		16 x 3
	440				106	116,6	424	3488	0,85	86,2					
	460				102	112,2	408	3498	0,83	87,5					
	575				82	90,2	328	3498	0,83	87,5					
	8WM-T0850				380	85	62	3	127	139,7					
440		109	119,9	436	3485				0,85	87,6					
460		105	115,5	420	3492				0,84	88,6					
575		84	92,4	336	3492				0,84	88,6					
8WM-T0900		380	90	66	3				138	151,8	552	3483	0,84	87,1	60.000
	440	119				130,9	476	3473	0,85	86,2					
	460	114				125,4	456	3483	0,84	87,1					
	575	91				100,1	364	3483	0,84	87,1					
	8WM-T1000	380				100	75	3	155	170,5	620	3490	0,85	86,9	
440		133	146,3	532	3482				0,86	86,4					
460		128	140,8	512	3490				0,85	86,9					
575		102	112,2	408	3490				0,85	86,9					
8WM-T1250		380	125	92	3				191	210,1	764	3500	0,83	88,5	70.000
	440	165				181,5	660	3487	0,84	87,6					
	460	158				173,8	632	3500	0,83	88,5					
	575	126				138,6	504	3500	0,83	88,5					
	8WM-T1500	380				150	110	3	240	264	960	3499	0,81	86,3	
440		203	223,3	812	3490				0,83	86					
460		198	217,8	792	3499				0,81	86,3					
575		158	173,8	632	3499				0,81	86,3					



# 8WM

## VERSIONS AVAILABLE



**D.O.L. VERSION**



**λ/Δ VERSION**



**UPPER AND LOWER BRACKET  
MADE IN GS400 SPHEROIDAL  
CAST IRON WITH CATAPHORESIS  
TREATMENT**



**FULLY MADE IN 316  
STAINLESS STEEL**



# 4OME

50 Hz - 60 Hz

**Submersible motors  
with built-in inverter  
electronics**



Made in Italy

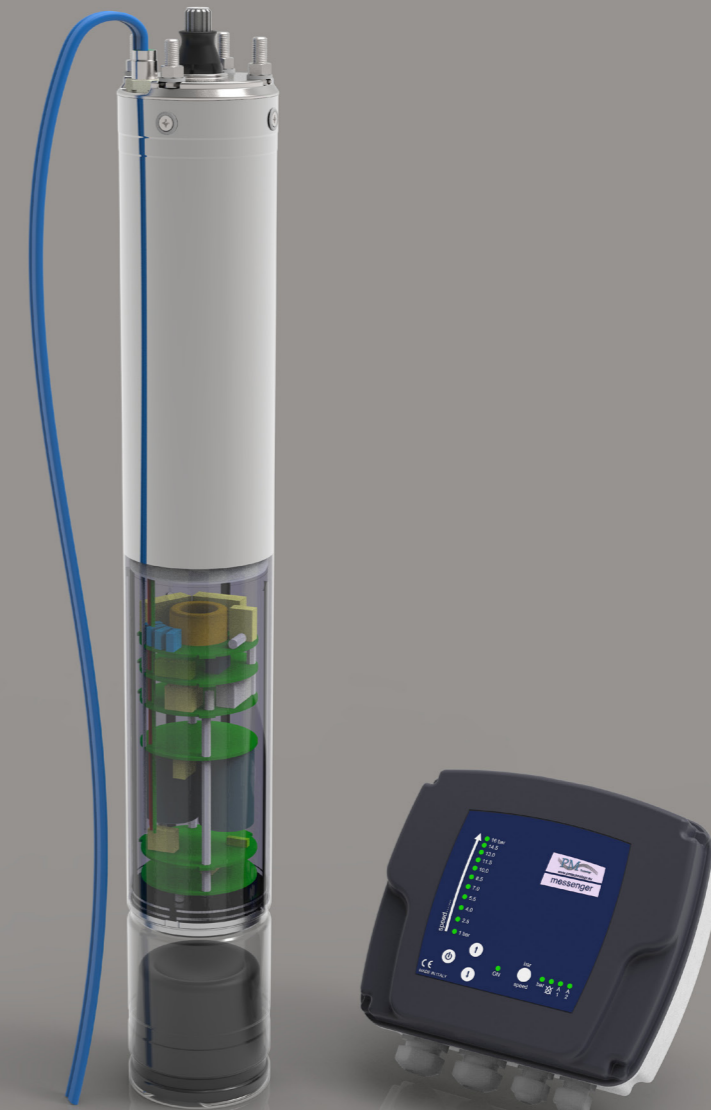

**4" VARIABLE SPEED SUBMERSIBLE MOTORS  
WITH INVERTER ON-BOARD**

## TECHNICAL SPECIFICATIONS

### MOTORS ENDOWED WITH ELECTRONIC INVERTER INTEGRATED ON-BOARD

#### 4" OIL FILLED SUBMERSIBLE MOTORS

**MOTOR/PUMP FLANGE**  
4" NEMA STANDARD

**POWERS**  
Max. motor's power output 1,1 kW at 55 Hz

**VOLTAGE**  
Input power line 1 x 230 V 50 / 60 Hz  
Three-phase motor

**THRUST LOAD**  
3000 N

## CONSTRUCTION FEATURES

**EXTERNAL SLEEVE** made in AISI 304L (Low Carbon) stainless steel.

**UPPER BRACKET** made in cast iron with cathoresis treatment.

**MECHANICAL SEAL** made in graphite/ceramic in the standard version; SIC/SIC version available upon request.

**BALL BEARING** duly oversized to ensure a long lasting motor.

**SHAFT PROJECTION** made in DUPLEX stainless steel.

**REMOVABLE POWER CABLE-CONNECTOR** to ensure a perfect sealing, also in the most critical conditions, and to aid maintenance operations. Homologated cable KTW, ACS, WRAS.

**INVERTER** placed under the motor and inside the same tube, fully resinate.

**INTERFACE MESSENGER.** Control panel endowed with pressure transducer 4-20 mA.

**100% TESTED**, all motors are tested at the end of the line. Seal and electrical checks are carried out on all motors.

## PATENTED MOTOR

Patent N. 0001397548  
Patent N. US 9,353,766 B2

## ACCESSORIES refer to page 152 -153 - 154

Sacrificial anode  
Different cable lengths

## OPERATING LIMITS

### DEGREE OF PROTECTION

Motor: IP 68  
MESSENGER: IP 55

**INSULATION CLASS**  
F

**VOLTAGE TOLERANCE**  
-10% / +10%

**PUMPED LIQUID TEMPERATURE**  
0°C – 35°C

**MIN. COOLING FLOW**  
0,1 m/s

**MAX. STARTS / HOUR**  
30

**MOUNTING**  
Vertical and/or horizontal

**MAX. IMMERSION DEPTH**  
200m

**PRESSURE TRANSDUCER**  
4-20 mA 0-16 bar

## DIMENSIONS

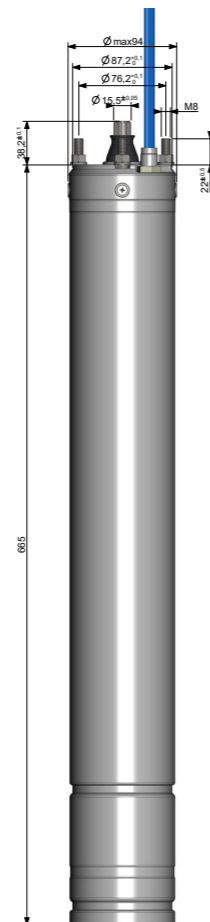

## THE ELECTRONIC REVOLUTION...

The 4OME submersible motor allows to keep the desired pressure constant in the installation ranging its speed of rotation. This is possible thanks to the electronic inverter integrated on-board and positioned immediately under the motor.

4OME respects NEMA standards and it can be therefore coupled with any kind of pump on the market having equal or inferior power to the maximum power of the motor.

## HOW THE PRODUCT IS COMPOSED:

### 4OME SUBMERSIBLE MOTOR

The submersible motor is three-phase oil filled with rotor made in copper, specifically designed in order to guarantee high efficiency and electric elasticity. The motor, together with the inverter integrated on-board, allows to have an operation range from 15 to 55 Hz by modulating continuously the speed, in order to keep the desired pressure, set by the user through the device *MESSENGER*, constant.

### MESSENGER: CONTROL AND MANAGEMENT DEVICE

*MESSENGER* is a panel composed of plastic and aluminium box containing an electronic card, used in surface to control pump by the operator. Through this device, user can set the pressure (automatic operation) or the rotation speed of the motor (manual operation), in addition to manage any alarms.

*MESSENGER* panel, in addition to being connected to the power line and to the motor, is also connected to a pressure gauge, necessary for reading pressure in the system.

*MESSENGER* device and the 4OME submersible motor communicate using the power line technology (**PLC, Power-line communication**). For this reason, it's not necessary to add any cable to allow communication between the two devices, since the same cables of motor power supply are used for communication.

### PRESSURE TRANSDUCER

0-16 bar 4-20 mA IP 65 included in the package supplied.

## MOTOR'S PROTECTIONS

- Protection against dry running and automatic reset of protection after 10-20-40-80-(120x10 times) minutes
- Electric protection against motor overload
- Phase failure protection
- Overvoltage protection
- Motor temperature protection

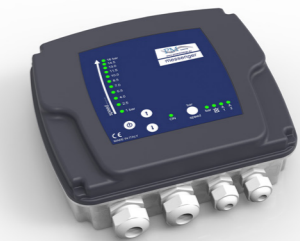
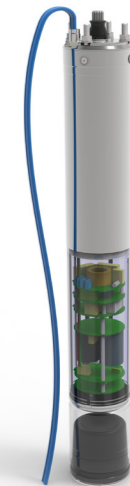

## ELECTRICAL DATA 4OME - 50/60Hz

Type	P <sub>2</sub> [Hp]	P <sub>2</sub> [kW]	Voltage [V]	Ph	I <sub>max</sub> [A]	P <sub>1max</sub> [kW]	rpm <sub>max</sub>	cos φ	Thrust Load [N]	Length A [mm]	Weight [kg]	Cable Length [m]	Cable Section [mm <sup>2</sup> ]
4OME-150	1,5	1,1	230	1	14,5	1,6	3100	0,80	3000	665	14,1	1,5	1,5

## CONNECTION DIAGRAM

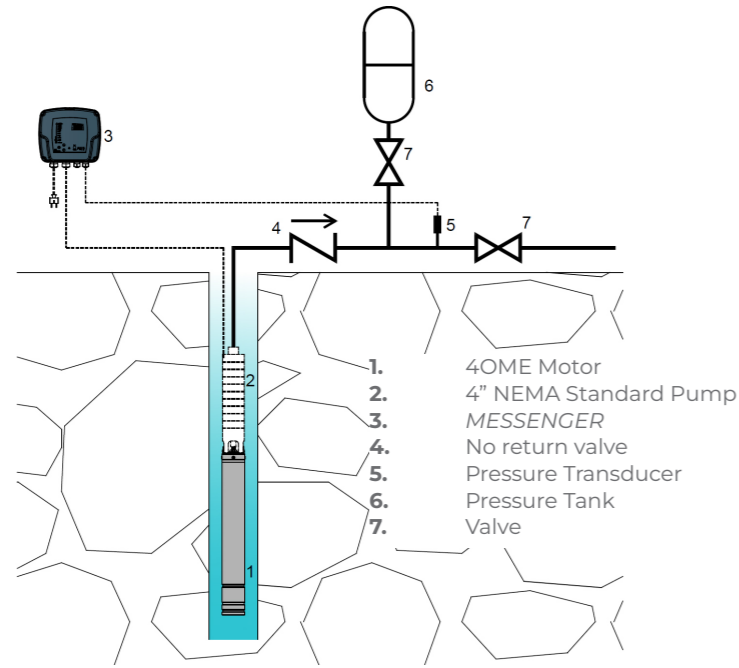

As you can see in the above connection diagram, hydraulic system is considerably simplified too. Indeed you just need to install a small pressure tank and a no return valve in order to keep the plant full of water.

Pressure tank is used to compensate any load losses and to limit the number of pump starts in case of a limited water demand.

MESSENGER panel is the user interface of the product. It's connected to the pressure gauge and to the motor.

## WHY SHOULD YOU USE A SUBMERSIBLE MOTOR WITH INVERTER INTEGRATED ON BOARD AND NOT AN EXTERNAL INVERTER?

- Inverter has been specifically designed to control that specific motor, not any pump, so the control is certainly more precise and efficient.
- External inverter connected with submersible electropumps, when the distance between inverter and electropump is greater than 20 meters, force you to install expensive filters to reduce the voltage peaks that occur. Furthermore, even if you install them, in some cases the filters are not sufficient and motor winding is irreparably damaged.

## ADVANTAGES

Inverter electric drive allows:

- to change the engine RPM (15-55 Hz) in order to keep the desired pressure in the system constant;
- to turn the motor on and off autonomously according to water demand;
- to start and stop the motor softly, avoiding water hammers and electrical absorption peaks;
- a great energy saving. Thanks to the variation of speed, it consumes just what exactly is used;
- sizing the system is even more easy;
- to have more pumps in one thanks to the variation of motor RPM. As consequence, it allows a remarkable reduction of the stock for distributors of the sector.

Using 4OME motor, **hydraulic operating curve** will no longer be the one indicated in the catalogue of the pump manufacturer but it **will be the whole area below the curve**.

Talking about a work area and no longer a curve, it allows to consume just what is required in that very moment and so it means an important electricity saving.

## EXAMPLE

Figure 1

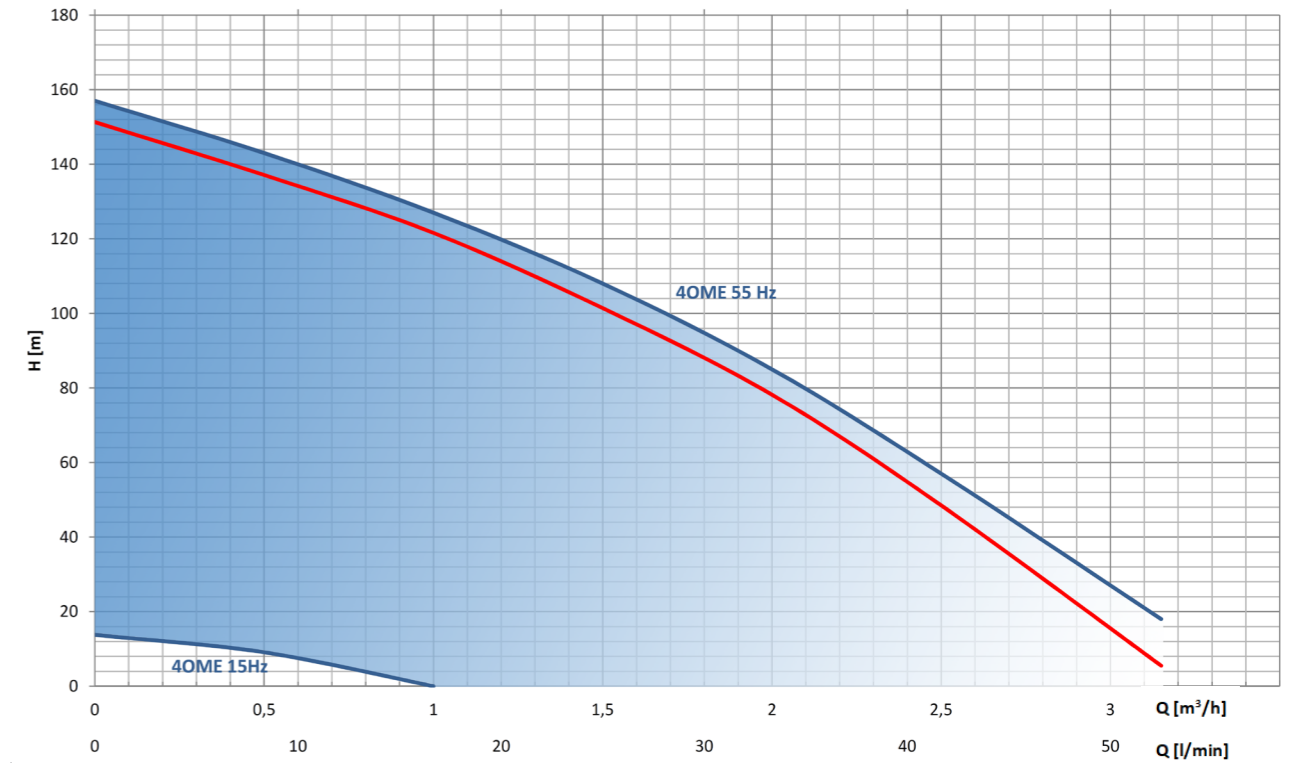
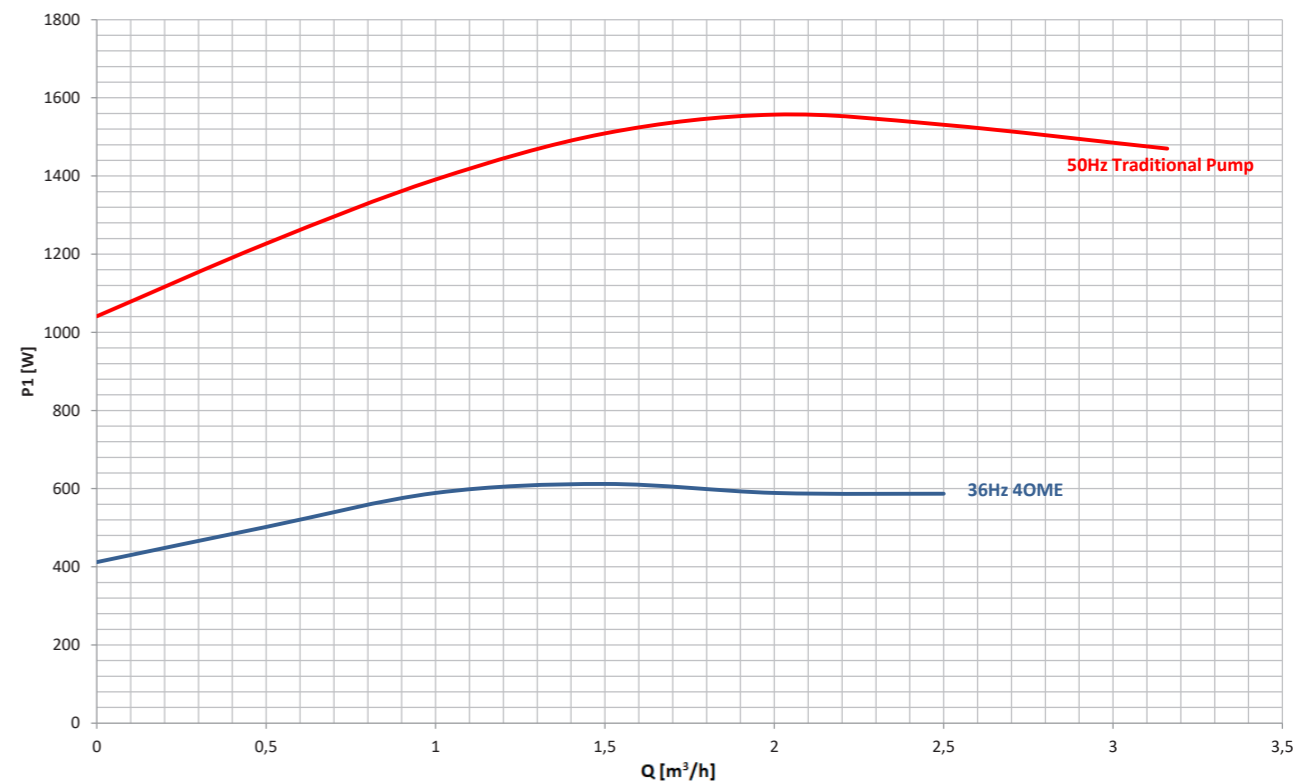

Figure 2



As you can see in the first diagram (Figure 1), the red curve represents a traditional 50Hz pump connected to standard motor without inverter. The blue area is the whole area of use of the same pump connected to the submersible 4OME motor, having 15 - 55Hz as operating range.

In the second diagram (Figure 2), you find an example of the difference of electrical absorption, at the same flow rate, between a pump connected to a traditional submersible motor and a pump connected to 4OME submersible motor. In this example, it is supposed that the operating point of the pump requires a motor rotation speed of 36Hz.



# 4OME SOLAR



## TECHNICAL SPECIFICATIONS

**MOTORS ENDOWED WITH ELECTRONIC INVERTER INTEGRATED ON-BOARD**

**4" OIL FILLED SUBMERSIBLE MOTORS**

**MOTOR/PUMP FLANGE**  
4" NEMA STANDARD

**POWERS**  
From 0,75 to 1,5 Hp

**VOLTAGE**  
Power supply from panels  
Three-phase motor

**THRUST LOAD**  
3000 N

## CONSTRUCTION FEATURES

**EXTERNAL SLEEVE** made in AISI 304L (Low Carbon) stainless steel.

**UPPER BRACKET** made in cast iron with cathoporesis treatment.

**MECHANICAL SEAL** made in graphite/ceramic in the standard version; SIC/SIC version available upon request.

**BALL BEARING** duly oversized to ensure a long lasting motor.

**SHAFT PROJECTION** made in DUPLEX stainless steel.

**REMOVABLE POWER CABLE-CONNECTOR** to ensure a perfect sealing, also in the most critical conditions, and to aid maintenance operations. Homologated cable KTW, ACS, WRAS.

**INVERTER** placed under the motor and inside the same tube, fully resinated.

**INTERFACE SOLAR MESSENGER.** Control panel, acting as the user interface.

**100% TESTED,** all motors are tested at the end of the line. Seal and electrical checks are carried out on all motors.

## PATENTED MOTOR

Patent N. 0001397548  
Patent N. US 9,353,766 B2

## ACCESSORIES *refer to page 152 - 153*

Sacrificial anode  
Different cable lengths

## OPERATING LIMITS

**DEGREE OF PROTECTION**  
Motor: IP 68  
SOLAR MESSENGER: IP 55

**INSULATION CLASS**  
F

**VOLTAGE TOLERANCE**  
-10% / +10%

**PUMPED LIQUID TEMPERATURE**  
0°C – 35°C

**MIN. COOLING FLOW**  
0,1 m/s

**MAX. STARTS / HOUR**  
30

**MOUNTING**  
Vertical and/or horizontal

**MAX. IMMERSION DEPTH**  
200m

## DIMENSIONS

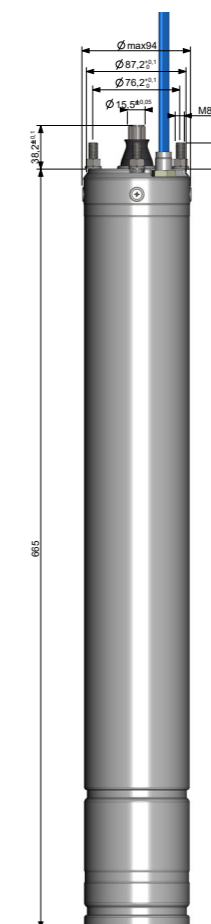

## 4" SOLAR-POWERED SUBMERSIBLE MOTORS WITH INVERTER ON-BOARD

## WORKING PRINCIPLE

The motor is directly powered by solar energy which is captured by PV modules converting solar radiation into electric power.

The heart of electronics' power, the inverter, is located inside the submersible motors. It manages the entire operation through MPPT algorithm, *Maximum Power Point Tracker*. This is a special algorithm to maximize electric power from solar irradiation on photovoltaic panels. This system ensures maximum power available in a certain moment by adjusting the revs of the motor. In fact, as solar irradiation varies, the device change the rotating speed of the motor, increasing or decreasing the flow rate or the hydraulic head of the electropump, thus ensuring the maximum values possible at any time. Therefore the electropump will continue to supply water as long as solar irradiation is sufficient to ensure its operation.

SOLAR MESSENGER electrical panel acts as an interface with the user above ground, self-managing the communication of the whole system.

4OME SOLAR respects NEMA standards and it can be therefore coupled with any kind of pump on the market having equal or inferior power to the maximum power of the motor.

## HOW THE PRODUCT IS COMPOSED:

### 4OME SOLAR SUBMERSIBLE MOTOR

The submersible motor is three-phase oil filled with rotor made in copper, specifically designed in order to guarantee high efficiency and electric elasticity. The motor is combined with the inverter integrated on-board.

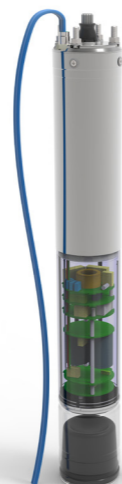

### SOLAR MESSENGER: CONTROL AND MANAGEMENT DEVICE

SOLAR MESSENGER is a panel composed of plastic box containing an electronic card, used in surface to control pump by the operator. Through this device, user can switch on and off the system, in addition to display and manage any alarms.

SOLAR MESSENGER panel, in addition to being connected to photovoltaic panels and motor, gives the opportunity to connect also a floating level.



## MOTOR'S PROTECTIONS

- Protection against dry running and automatic reset of protection after 10-20-40-80-(120x10 times) minutes
- Electric protection against motor overload
- Phase failure protection
- Overvoltage protection
- Motor temperature protection

## ADVANTAGES

Inverter integrated on-board electric drive allows:

- to change the engine RPM always ensuring the highest level of water;
- to start and stop the motor softly, avoiding water hammers and electrical absorption peaks;
- not to install expensive filters or shielded cables to prevent motor damage, being the inverter integrated.

## CONNECTION DIAGRAM

As you can see in the connection diagram, you just need to install the motor with the desired pump and connect it with the SOLAR MESSENGER panel on the surface. SOLAR MESSENGER panel, in turn, will be connected with photovoltaic panels.

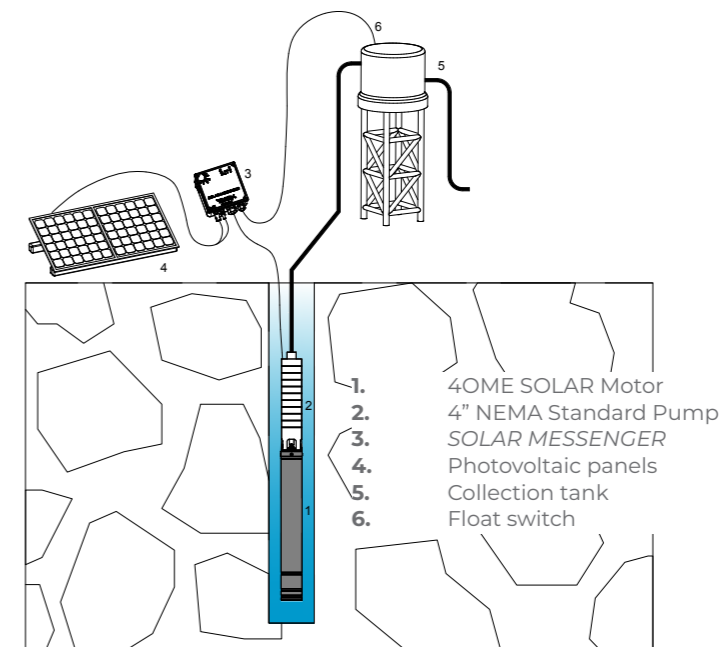

## ELECTRICAL DATA 4OME SOLAR

MOTOR DATA													PANELS POWER SUPPLY		
Type	P <sub>2</sub> [Hp]	P <sub>2</sub> [kW]	Motor Voltage [V <sub>ac</sub> ]	Ph	I <sub>max</sub> [A]	P <sub>1max</sub> [W]	rpm	Thrust Load [N]	Length A [mm]	Weight [kg]	Cable Length [m]	Cable Section [mm <sup>2</sup> ]	Voltage * [V <sub>oc</sub> ]	Minimum Output [W <sub>p</sub> ]	Minimum Current [A]
4OME SOLAR-075	0,75	0,55	100	3	6,5	850	2850	3000	665	14,1	1,5	1,5	140-220	>900	>7
4OME SOLAR-100	1	0,75	100	3	8,5	1150	2850	3000	665	14,1	1,5	1,5	140-220	>1300	>9
4OME SOLAR-150	1,5	1,1	100	3	11,5	1700	2850	3000	665	14,1	1,5	1,5	140-220	>1800	>12

\* The incoming voltage from solar panels must never exceed the specified maximum voltage of 220 V<sub>DC</sub>. Otherwise, the motor could be damaged irreparably. Unlike, a voltage lower than the one indicated (140 V<sub>DC</sub>), doesn't guarantee the full RPM of the motor.

## EXAMPLE

### INSTALLATION OF 4OME SOLAR-150 MOTOR

#### SIZING OF PHOTOVOLTAIC PANELS

Example of panels:

W<sub>p</sub> 240 W (power supplied by the single panel)

V<sub>p</sub> 30 V<sub>DC</sub> (maximum voltage supplied by the single panel)

V<sub>OC</sub> 37 V<sub>DC</sub> (open-circuit voltage of the single panel)

I<sub>p</sub> 8 A (minimum current supplied by the single panel)

#### How many panels are needed and how should they be connected?

Based on the electrical data showed in the above chart, 4OME SOLAR-150 model requires, to operate the system at full capacity, of:

- 1800 W<sub>p</sub>. This means that  $1800/240 = 7,5 \rightarrow 8$  panels are needed
- minimum 140 V<sub>DC</sub>. So,  $140/30 = 4,6 \rightarrow 5$  panels serially connected together must be installed
- current not less than 12 A. Each panels in this example generates 8 A so, in order to guarantee 12 A,  $12/8 = 1,5 \rightarrow 2$  panels in parallel must be installed, obtaining 16 A in case of maximum irradiation.

In this case, the ideal photovoltaic system consists of 10 panels in total. Two strings from 5 panels (in series) each and connected in parallel together, as from the connection diagram in figure.

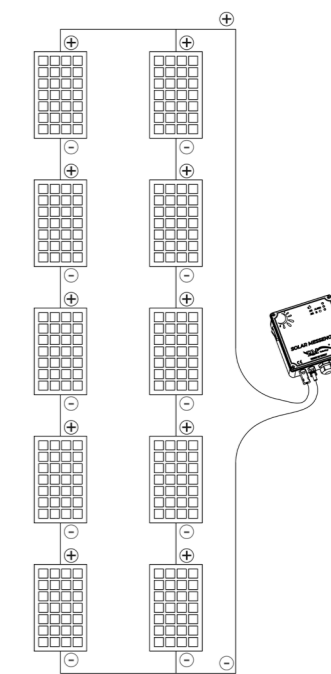

# FROG

50 Hz - 60 Hz

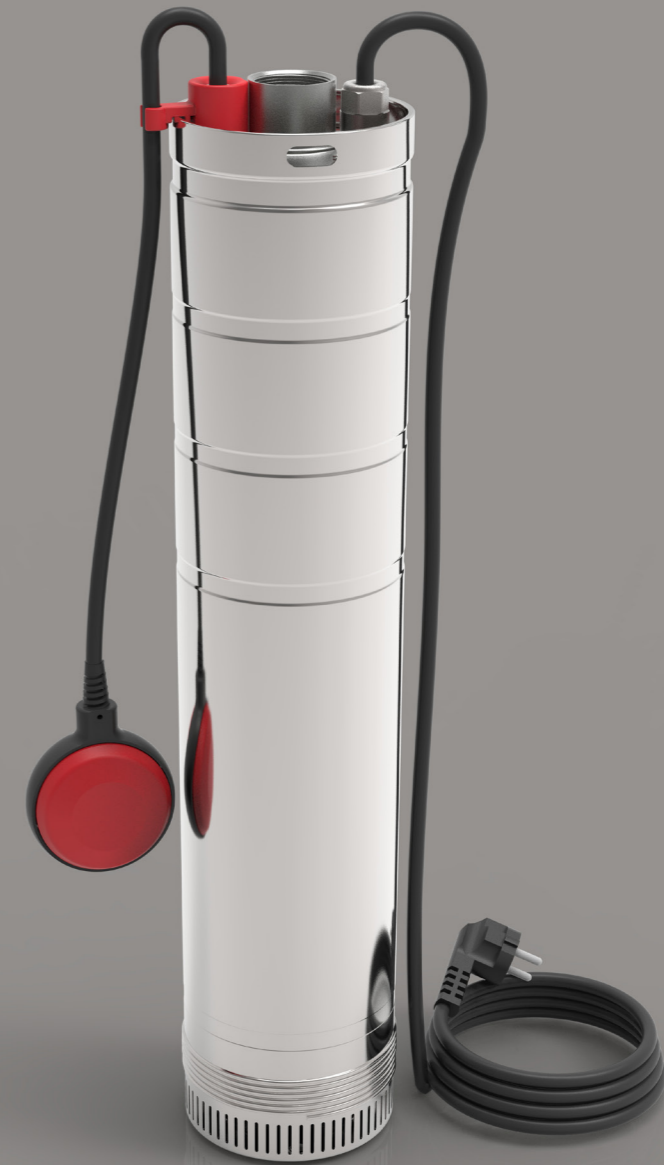

## Submersible electropumps



Made in Italy

**5" SUBMERSIBLE MONOBLOCK  
ELECTROPUMPS**

## TECHNICAL SPECIFICATIONS

**POWERS**  
 3 m<sup>3</sup>/h: from 0,6 Hp to 2 Hp single-phase / three-phase 50 Hz  
 from 0,8 Hp to 2 Hp single-phase / three-phase 60 Hz  
 5 m<sup>3</sup>/h: from 0,8 Hp to 2 Hp single-phase / three-phase 50 Hz  
 from 1,2 Hp to 2 Hp single-phase / three-phase 60 Hz

**VOLTAGE**  
 Single-phase: 230 V / 50 Hz - 220 V / 60 Hz  
 Three-phase: 230;400 V / 50 Hz - 220;380 V / 60 Hz

## CONSTRUCTION FEATURES

**CONNECTION SYSTEM** by means of connector.

**PUMP OUTLET** made in AISI 304 stainless steel.

**ASYNCHRONOUS MOTOR COOLED BY PUMPED LIQUID**

**SLEEVE** made in 304L stainless steel (Low carbon) to avoid possible corrosions of the welding.

**DOUBLE MECHANICAL SEAL** with interposed oil chamber.

**B-CLASS CONDENSER**, meeting long-lasting features (three times a standard condenser).

**IMPELLERS AND DIFFUSERS** made in techno-polymer:

- higher performance;
- higher resistance to sand.

**INTAKE FILTER** made in 304 stainless steel.

**REMOVABLE CABLE CONNECTOR** H07RN-F type.

**AUTOMATIC VERSIONS WITH REMOVABLE FLOAT SWITCH** for applications at great depths (40 m).

**100% TESTED**, all the electropumps are electrically and hydraulically tested at the end of the line.

## DIMENSIONS

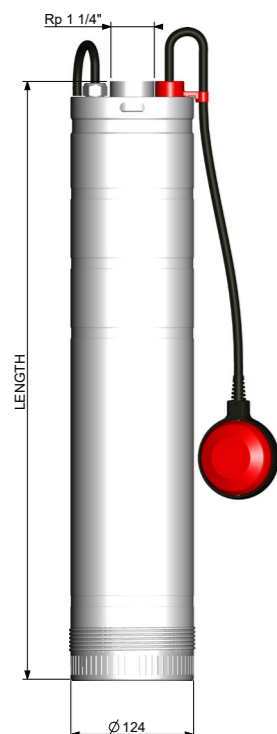

## OPERATING LIMITS

**PROTECTION**  
 IP 68

**INSULATION CLASS**  
 F

**VOLTAGE TOLERANCE**  
 -10% / +10%

**PUMPED LIQUID TEMPERATURE**  
 0°C – 35°C

**MAX. STARTS / HOUR**  
 40

**MAX. AMOUNT OF SAND TOLERATED IN WATER**  
 50 g/m<sup>3</sup>

**MAX. IMMERSION DEPTH**  
 40m

**SINGLE-PHASE VERSION**  
 Featuring a condenser with overload protection and automatic resetting system.

**3-20S, 5-20S, 3-20S6, 5-20S6 AND THREE-PHASE SERIES**  
 Not feature overload protection.

## VERSIONS UPON REQUEST

Different thrust load  
 Different voltage  
 Version with KTW, WRAS, ACS type-approved cable  
 Versions with or without float switch  
 External capacitor (*minimum quantity required*)

## ACCESSORIES refer to page 153 - 154

Cable lengths: 10 m or 20 m  
 Sacrificial anode  
 Float switch with removable connector  
 FROG disassembly kit  
 Electrical plug of different standards

## FLOAT SWITCH WITH “PLUG IN & PLUG OUT” SYSTEM

- Guarantees a perfect sealing
- Gives the option of using/selling the electropump with or without float switch just connecting or disconnecting it
- Reduces stock because electropump can be bought with or without float switch
- Allows a fast and safe maintenance cause superior pump side can be completely removed

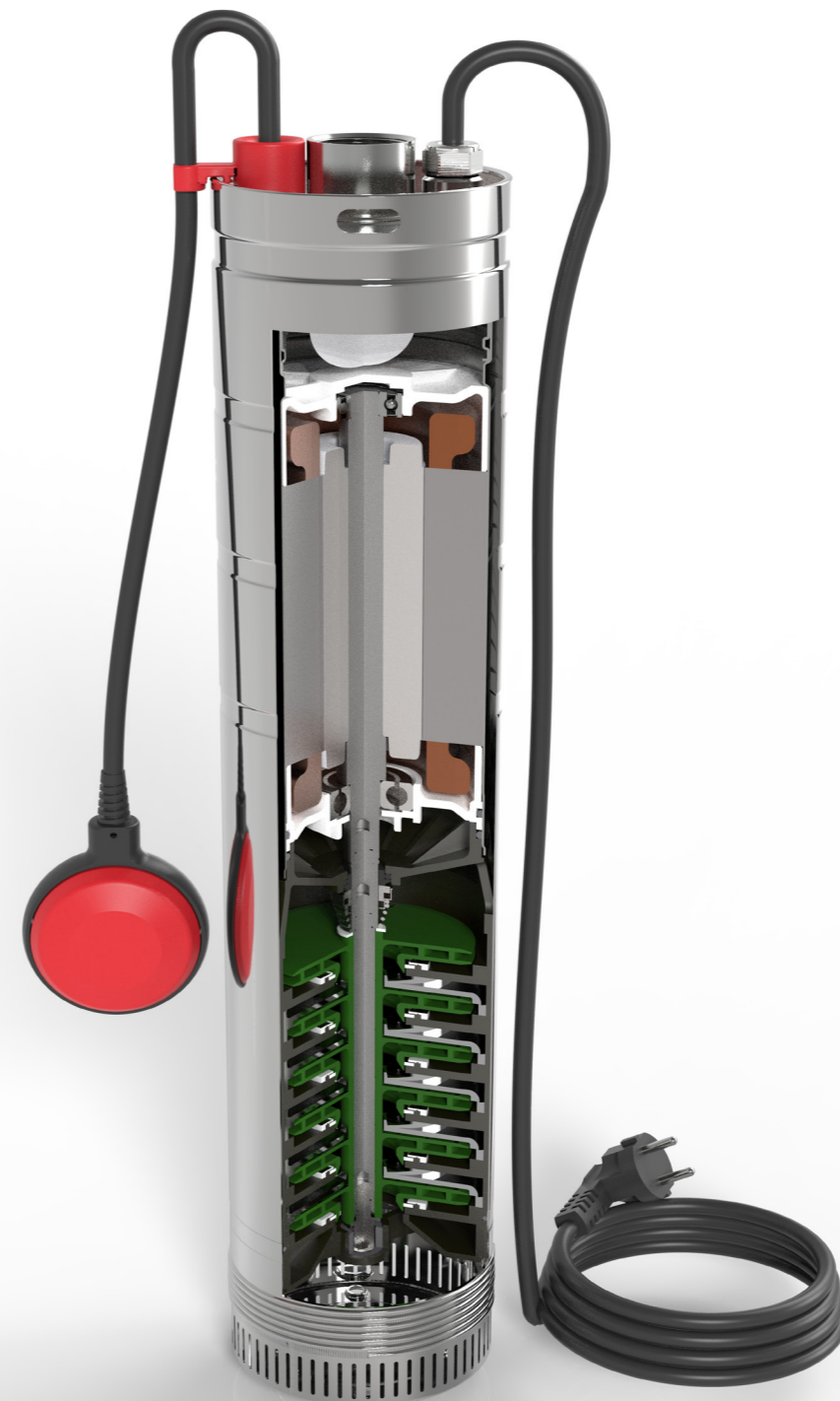

SCAN TO see how to install the float switch correctly.



## MODELS

50Hz Model		60Hz Model		Dimension		Cable Length [m]
Single-phase 230 V	Three-phase 230/400 V	Single-phase 220 V	Three-phase 220/380 V	Length [mm]	Weight [kg]	
FROG 3 - 06S	FROG 3 - 06T	-	-	439	14	10
FROG 3 - 08S	FROG 3 - 08T	FROG 3 - 08S6	FROG 3 - 08T6	495	15,5	
FROG 3 - 10S	FROG 3 - 10T	FROG 3 - 10S6	FROG 3 - 10T6	521	16,5	
FROG 3 - 12S	FROG 3 - 12T	FROG 3 - 12S6	FROG 3 - 12T6	590	19	
FROG 3 - 15S	FROG 3 - 15T	FROG 3 - 15S6	FROG 3 - 15T6	616	20	
FROG 3 - 20S	FROG 3 - 20T	FROG 3 - 20S6	FROG 3 - 20T6	698	23,5	
FROG 5 - 08S	FROG 5 - 08T	-	-	469	16	
FROG 5 - 12S	FROG 5 - 12T	FROG 5 - 12S6	FROG 5 - 12T6	515	17,5	
FROG 5 - 15S	FROG 5 - 15T	FROG 5 - 15S6	FROG 5 - 15T6	541	18,5	
FROG 5 - 20S	FROG 5 - 20T	FROG 5 - 20S6	FROG 5 - 20T6	620	20,5	



**OPERATING CURVES FROG - 50Hz**

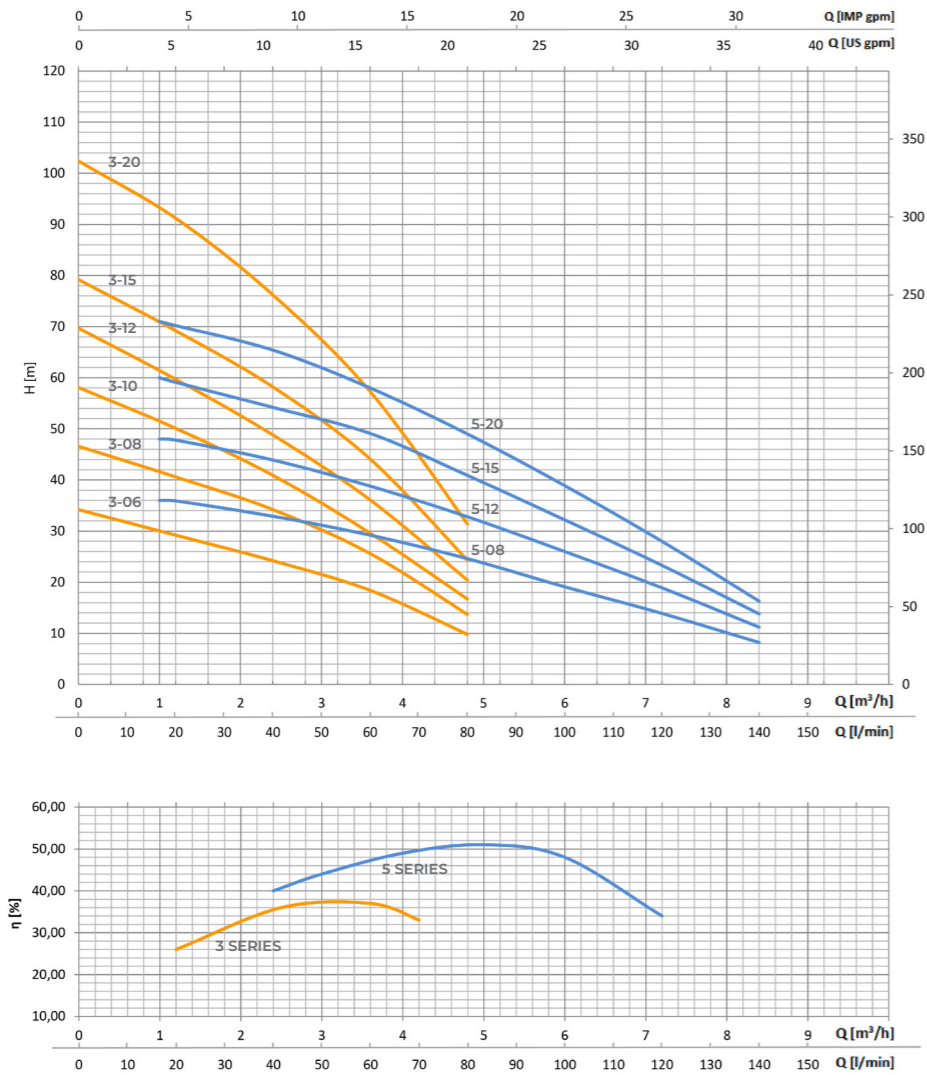

**OPERATING CURVES FROG - 60Hz**

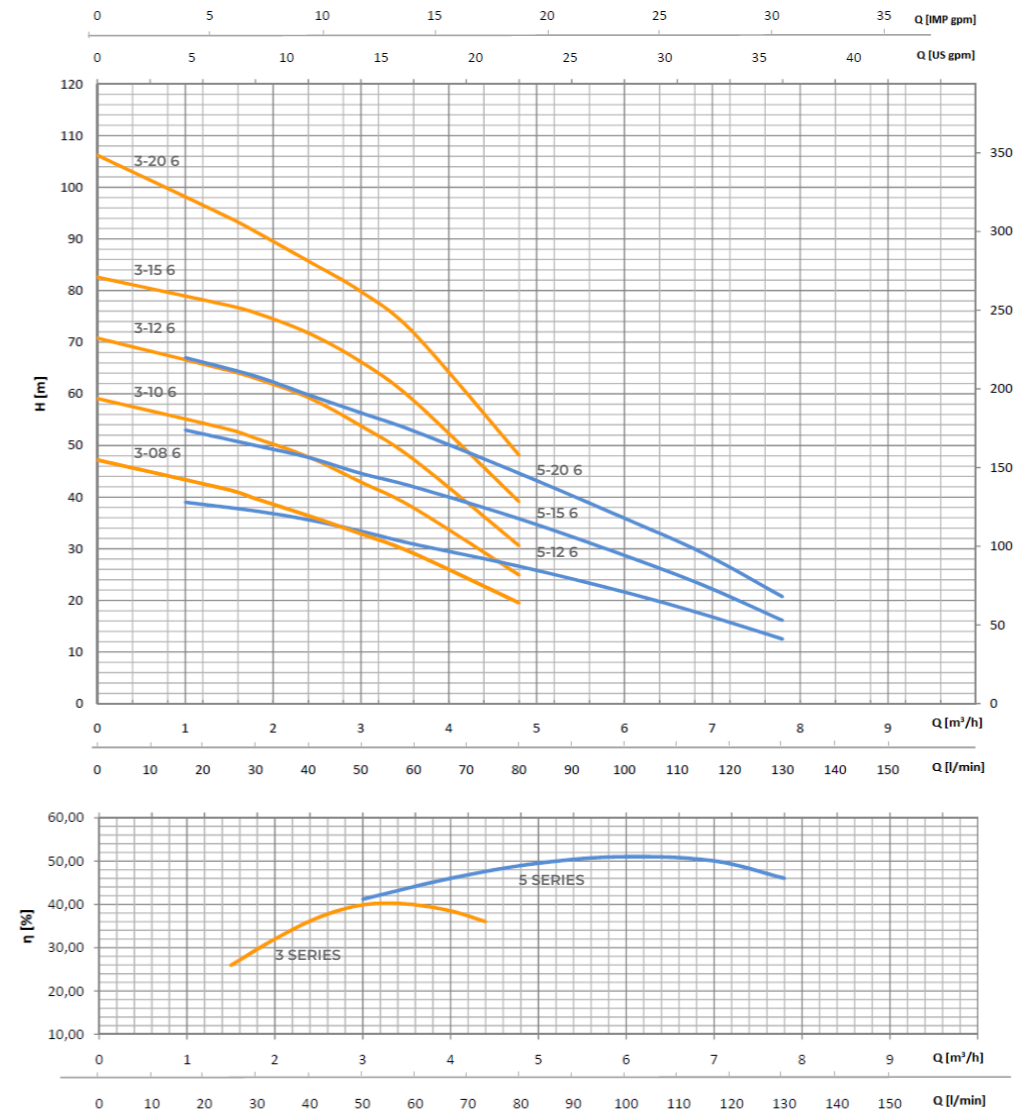

**HYDRAULIC PERFORMANCE TABLE FROG - 50Hz**

Type		P <sub>2</sub>		N. of Stage	Q (Flow Rate)								
Single-phase 230 V	Three-phase 230/400 V	[Hp]	[kW]		[l/min]	0	20	40	60	80	100	120	140
					[m³/h]	0	1,2	2,4	3,6	4,8	6	7,2	8,4
H (Total Head) [m]													
FROG 3 - 06S	FROG 3 - 06T	0,6	0,45	3	34,2	29,2	24,2	18,4	9,8	-	-	-	
FROG 3 - 08S	FROG 3 - 08T	0,8	0,6	4	46,6	40,6	34,2	25,6	13,7	-	-	-	
FROG 3 - 10S	FROG 3 - 10T	1	0,75	5	58,1	50,1	40,9	29,6	16,7	-	-	-	
FROG 3 - 12S	FROG 3 - 12T	1,2	0,9	6	69,7	59,7	48,8	36,1	20,4	-	-	-	
FROG 3 - 15S	FROG 3 - 15T	1,5	1,1	7	79,2	69,2	58,2	44,1	24,3	-	-	-	
FROG 3 - 20S	FROG 3 - 20T	2	1,5	9	102,4	91,2	76,2	57,3	31,4	-	-	-	
FROG 5 - 08S	FROG 5 - 08T	0,8	0,6	3	37,2	35,9	32,9	29,2	24,6	19,1	13,9	8,2	
FROG 5 - 12S	FROG 5 - 12T	1,2	0,9	4	49,6	47,8	43,9	38,8	32,8	26	18,9	11,2	
FROG 5 - 15S	FROG 5 - 15T	1,5	1,1	5	61,5	59,1	54,2	49,1	40,9	32,2	23,3	13,8	
FROG 5 - 20S	FROG 5 - 20T	2	1,5	6	74,4	70,2	65,4	58	49	38,9	28	16,3	

**ELECTRICAL DATA FROG - 50Hz**

Type	P <sub>1</sub> [kW] (Max Absorbed Power)	I [A] (Max Absorbed Current)	Capacitor 450 V [μF]	Type	P <sub>1</sub> [kW] (Max Absorbed Power)	I [A] (Max Absorbed Current)	
						230 V	400 V
Single-phase 230 V				Three-phase 230/400 V			
FROG 3 - 06S	0,81	3,7	20	FROG 3 - 06T	0,82	2,4	1,4
FROG 3 - 08S	1	5,1	25	FROG 3 - 08T	1,04	2,9	1,9
FROG 3 - 10S	1,22	5,7	25	FROG 3 - 10T	1,3	3,8	2,2
FROG 3 - 12S	1,4	6,5	35	FROG 3 - 12T	1,32	4,5	2,6
FROG 3 - 15S	1,65	7,6	35	FROG 3 - 15T	1,51	4,8	2,9
FROG 3 - 20S	2,15	9,8	40	FROG 3 - 20T	2,05	5,7	3,5
FROG 5 - 08S	1,1	5,2	25	FROG 5 - 08T	1,12	4	2,1
FROG 5 - 12S	1,32	6,4	35	FROG 5 - 12T	1,29	4,4	2,5
FROG 5 - 15S	1,7	8	35	FROG 5 - 15T	1,64	4,9	3
FROG 5 - 20S	1,95	9,4	40	FROG 5 - 20T	1,92	5,7	3,7

**HYDRAULIC PERFORMANCE TABLE FROG - 60Hz**

Type		P <sub>2</sub>		N. of Stage	Q (Flow Rate)										
Single-phase 220 V	Three-phase 220/380 V	[Hp]	[kW]		[l/min]	0	25	30	40	50	60	80	100	115	130
					[m³/h]	0	1,5	1,8	2,4	3	3,6	4,8	6	6,9	7,8
H (Total Head) [m]															
FROG 3-08S6	FROG 3-08T6	0,8	0,6	4	47,2	41,4	39,7	36,4	32,9	29,1	19,5	-	-	-	
FROG 3-10S6	FROG 3-10T6	1	0,75	5	59,1	53,1	51,4	47,8	42,9	37,9	24,9	-	-	-	
FROG 3-12S6	FROG 3-12T6	1,2	0,9	6	70,8	64,5	63	59,3	53,8	47,3	30,6	-	-	-	
FROG 3-15S6	FROG 3-15T6	1,5	1,1	7	82,6	77,1	75,1	71,8	66,2	58,7	39,1	-	-	-	
FROG 3-20S6	FROG 3-20T6	2	1,5	9	106,2	94,1	91,4	85,7	79,8	71,8	48,1	-	-	-	
FROG 5-12S6	FROG 5-12T6	1,2	0,9	4	45,4	42,6	37,3	35,6	33,4	30,9	26,6	21,6	17,3	12,5	
FROG 5-15S6	FROG 5-15T6	1,5	1,1	5	56,7	53,8	50	47,7	44,6	42	35,8	28,7	22,9	16,1	
FROG 5-20S6	FROG 5-20T6	2	1,5	6	68	66,2	63,4	59,8	56,3	52,8	44,6	35,9	29,1	20,7	

**ELECTRICAL DATA FROG - 60Hz**

Type	P <sub>1</sub> [kW] (Max Absorbed Power)	I [A] (Max Absorbed Current)	Capacitor 450 V [μF]	Type	P <sub>1</sub> [kW] (Max Absorbed Power)	I [A] (Max Absorbed Current)	
						220 V	380 V
Single-phase 220 V				Three-phase 220/380 V			
FROG 3-08S6	1,05	4,8	25	FROG 3-08T6	1,06	2,9	1,7
FROG 3-10S6	1,24	5,9	25	FROG 3-10T6	1,31	3,6	2,1
FROG 3-12S6	1,42	7,1	35	FROG 3-12T6	1,37	3,9	2,3
FROG 3-15S6	1,67	8	35	FROG 3-15T6	1,56	4,4	2,6
FROG 3-20S6	2,16	10,1	40	FROG 3-20T6	2,08	5,4	3,2
FROG 5-12S6	1,34	6,3	35	FROG 5-12T6	1,31	3,6	2,1
FROG 5-15S6	1,72	7,3	35	FROG 5-15T6	1,67	4,4	2,6
FROG 5-20S6	1,91	9,7	40	FROG 5-20T6	1,89	4,9	2,9

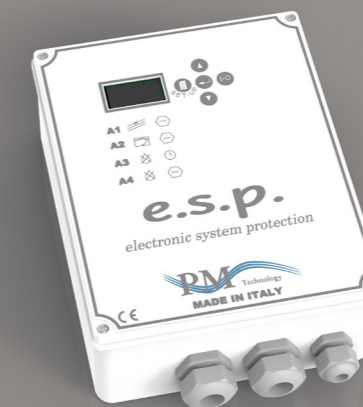

## ELECTRONIC SYSTEM PROTECTION

*E.S.P.* is a control board for the protection and control of electro-pumps.

The main feature of this device is the protection of the motor pump from dry running by checking the motor cosphi.

Cosphi and current motor parameters can be manually set by the operator (**MANUAL FUNCTION**), by inserting a minimum Cosphi threshold value and a maximum current value. If these values are exceeded, the device will activate to protect the motor pump.

In addition to manual operation, the *E.S.P.* has an automatic mode (**AUTOMATIC FUNCTION**) with which it can automatically set necessary cosphi and current value to protect the motor pump.

All settings and displays are done through a keyboard and a display.

*E.S.P.* is available as three-phase and single-phase version: the latter comes with the possibility to insert a capacitor (**not included**).

*E.S.P.* is also supplied with a digital auxiliary input device to start or stop the pump. A float, a pressure switch, ..., may be connected to this input.

## MAIN FEATURES AND PROTECTIONS

- Protection against dry running and automatic reset of protection after 10-20-40-80-(120x10 times) minutes
- Electrical protection against motor overload
- Protection against no-phase (three-phase version)
- Protection against over voltage
- Output with cable glands
- IP 55 protection class

# Control panels and accessories

 Made in Italy

## SPECIFICATIONS *E.S.P.* - 50/60Hz

Type	Approximate Power		Phase	Voltage [V]	Max. Current [A]	Weight [Kg]	Dimension [mm]
	[Hp]	[kW]					
Sline20	0,5 - 3	0,37 - 2,2	1	230	20	1,8	240 x 190 x 90
Tline10	0,5 - 4	0,37 - 3	3	400	10	1,8	240 x 190 x 90
Tline20	5,5 - 10	4 - 7,5	3	400	20	1,8	240 x 190 x 90
Tline30	12,5 - 15	9,2 - 11	3	400	30	2,4	240 x 190 x 90

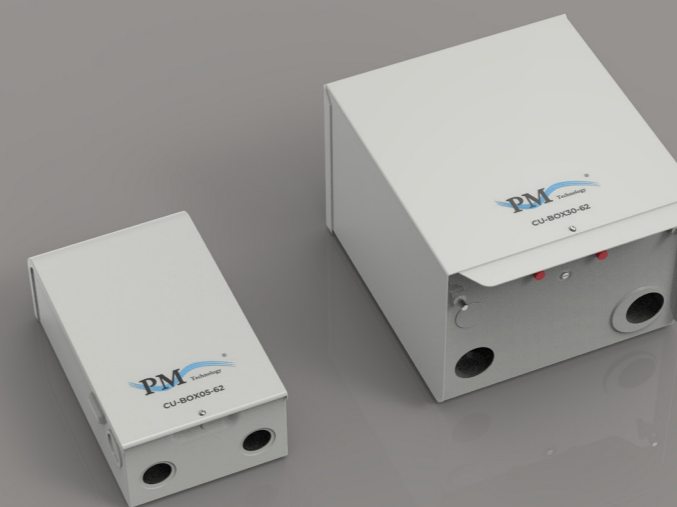

### CONTROL BOX

C-BOX series of control panels are designed to protect single-phase electropumps.

Endowed with thermal-amperometric protection and start capacitor, in proportion with motor size.

### MAIN FEATURES AND PROTECTIONS

- Box made of thermoplastic insulating material
- On / Off switch
- Externally resettable thermal protection
- Output with cable glands
- IP 54 protection class
- Upon request, it's possible to supply them with plug for power outlet

### SPECIFICATIONS C-BOX - 50Hz

Type	Power		Voltage [V]	Protect. [A]	Capacitor [µF]	Weight [Kg]	Dimension [mm]
	[Hp]	[kW]					
C-BOX20	0,5	0,37	220/230	5	20	0,75	170 x 150 x 70
C-BOX20D	0,5	0,37		5	20+(36/43)	1	200 x 155 x 80
C-BOX25	0,75	0,55	220/230	7	25	0,75	170 x 150 x 70
C-BOX25D	0,75	0,55		7	25+(53/64)	1	200 x 155 x 80
C-BOX35	1	0,75	220/230	8	35	0,75	170 x 150 x 70
C-BOX35D	1	0,75		8	35+(88/106)	1	200 x 155 x 80
C-BOX40	1,5	1,1	220/230	11	40	0,75	170 x 150 x 70
C-BOX40D	1,5	1,1		11	40+(110/125)	1	200 x 155 x 80
C-BOX60	2	1,5	220/230	14	60	1	200 x 155 x 80
C-BOX60D	2	1,5		14	60+(125/160)	1,6	255 x 195 x 100
C-BOX70	3 WM	2,2	220/230	20	70	1	200 x 155 x 80
C-BOX70D	3 WM	2,2		20	70+(200/250)	1,6	255 x 195 x 100
C-BOX80	3 OM	2,2	220/230	20	80	1	200 x 155 x 80
C-BOX80D	3 OM	2,2		20	80+(200/250)	1,6	255 x 195 x 100
C-BOX90	4	3	220/230	30	90	1,6	255 x 195 x 100
C-BOX90D	4	3		30	90+(250/300)	2,4	310 x 240 x 110
C-BOX100D	5	3,7	220/230	32	100+(250/300)	2,4	310 x 240 x 110
C-BOX120D	5,5	4	220/230	35	120+(250/300)	2,4	310 x 240 x 110

### SPECIFICATIONS C-BOX - 60Hz

Type	Power		Voltage [V]	Protect. [A]	Capacitor [µF]	Weight [Kg]	Dimension [mm]
	[Hp]	[kW]					
C-BOX20-62	0,5	0,37	220/230	6	20	0,75	170 x 150 x 70
C-BOX80-61	0,5	0,37	110/115	11	80	1	200 x 155 x 80
C-BOX25-62	0,75	0,55	220/230	8	25	0,75	170 x 150 x 70
C-BOX100-61	0,75	0,55	110/115	14	100	1	200 x 155 x 80
C-BOX35-62	1	0,75	220/230	9	35	0,75	170 x 150 x 70
C-BOX120-61	1	0,75	110/115	18	120	1,6	255 x 195 x 100
C-BOX40-62	1,5	1,1	220/230	12	40	0,75	170 x 150 x 70
C-BOX40D-62	1,5	1,1		12	40+(110/125)	1	200 x 155 x 80
C-BOX60-62	2	1,5	220/230	14	60	1	200 x 155 x 80
C-BOX60D-62	2	1,5		14	60+(125/160)	1,6	255 x 195 x 100
C-BOX80-62	3	2,2	220/230	20	80	1	200 x 155 x 80
C-BOX80D-62	3	2,2		20	80+(200/250)	1,6	255 x 195 x 100
C-BOX100D-62	5	3,7	220/230	32	100+(250/300)	2,4	310 x 240 x 110
C-BOX120D-62	5,5	4	220/230	35	120+(250/300)	2,4	310 x 240 x 110

### CONTROL BOX

CU-BOX series of control panels are designed for the starter of 4" single-phase water cooled submersible motors canned type of 4WMU 60 Hz series.

### MAIN FEATURES

- Painted metal box
- Start capacitor for single-phase motors 3-WIRE CSIR (powers from 1/2 to 1 Hp)
- Start + Run capacitor for single-phase motors CSCR (powers from 1.5 to 5 Hp)
- Volumetric Relay
- External access to thermal protection for single-phase motors 3-WIRE CSCR (powers from 1.5 to 5 Hp)
- Suitable for in and outdoor use

### SPECIFICATIONS CU-BOX - 60Hz

Type	Power		Voltage [V]	Start Capacitor [mF]	Run Capacitor [mF]	Weight		Dimension	
	[Hp]	[kW]				[Kg]	[lb]	[mm]	[in]
CU-BOX05-61	1/2	0,37	110/115	250-300 (125 V)	-	1,2	2,6	130 x 77 x 215	5.1 x 3 x 8.5
CU-BOX05-62	1/2	0,37	220/230	59-71 (250 V)	-	1,2	2,6	130 x 77 x 215	5.1 x 3 x 8.5
CU-BOX07-61	3/4	0,55	110/115	250-300 (125 V)	-	1,2	2,6	130 x 77 x 215	5.1 x 3 x 8.5
CU-BOX07-62	3/4	0,55	220/230	86-103 (250 V)	-	1,2	2,6	130 x 77 x 215	5.1 x 3 x 8.5
CU-BOX10-62	1	0,75	220/230	105-126 (250 V)	-	1,2	2,6	130 x 77 x 215	5.1 x 3 x 8.5
CU-BOX15-62	1,5	1,1	220/230	105-126 (250 V)	10 (400 V)	2,5	5,5	205 x 240 x 148	8.1 x 9.5 x 5.8
CU-BOX20-62	2	1,5	220/230	105-126 (250 V)	20 (400 V)	2,5	5,5	205 x 240 x 148	8.1 x 9.5 x 5.8
CU-BOX30-62	3	2,2	220/230	208-250 (250 V)	45 (400 V)	2,5	5,5	205 x 240 x 148	8.1 x 9.5 x 5.8
CU-BOX50-62	5	3,7	220/230	270-324(250 V)	80 (400 V)	2,5	5,5	205 x 240 x 148	8.1 x 9.5 x 5.8



## INVERTER CONTROL BOX

WHITE series of inverter electronic panels are developed for the control of asynchronous electropumps and are suitable for installation both on new systems and on existing ones.

### MAIN FEATURES

- Extremely durable aluminum box, with excellent thermal dissipation
- Cooling fan that activates on demand
- IP55 protection class
- Smartphone interface
- 2 digital inputs configurable via app
- 2 digital outputs configurable via app
- 1 analog input 4-20mA (dedicated to pressure gauge)
- 1 analog input 4-20mA or 0-10V
- RS485 MODBUS RTU
- Bluetooth® SMART 4.0

### PROTECTIONS

- Protection against dry running
- Protection against over and under voltage
- Electrical protection against motor overload
- Protection against no-phase
- Protection and control of maximum operating temperature

### APPLICATIONS

- Water supply
- Submersible pumps
- Water distribution
- Pressurization
- Irrigation systems
- Water treatment
- Industrial cooling or heating systems
- Fountains

### DIMENSIONS

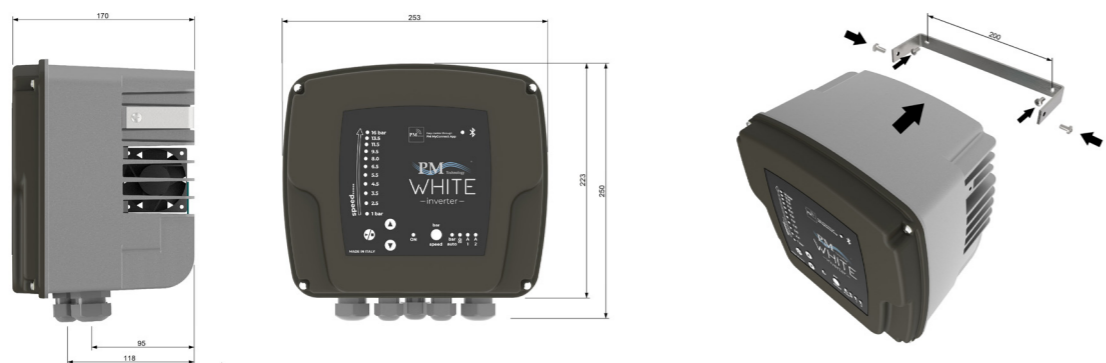

### SPECIFICATIONS WHITE - 50/60Hz

Type	V <sub>in</sub>	V <sub>out</sub>	Motor I <sub>max</sub> [A]	Motor P <sub>2 max</sub> [kW]	Weight [Kg]	Dimension [mm]
WHITE 102	1x230	3x230	7.5	1.5	4.3	253 x 250 x 170
WHITE S 102	1x230	1x230	11	1.5	4.3	253 x 250 x 170

## ADVANTAGES

- Device easy to use and intuitive.
- It ensures the protection of the electropump and the system thanks to specific parameters and controls.
- It extends the life of the electropump: working at a lower speed, it allows to stress less the mechanical parts of the same.
- Possibility to work even in wet environments (IP 55 protection class).
- It guarantees energy savings. Thanks to WHITE, the electropump can work at variable speed, keeping the pressure constant. The energy consumption will therefore vary according to the real water needs with a consequent economic saving.
- Flexibility: thanks to PM MyConnect app, it's possible to expand the uses and set about 50 parameters in order to adapt the system to the needs of the plant.
- Simplified service procedure: thanks to PM MyConnect app, it's possible to send the current inverter configuration to the PM technicians, in order to analyse any problems or simply to make specific corrections for the system.

## CONNECTION DIAGRAM

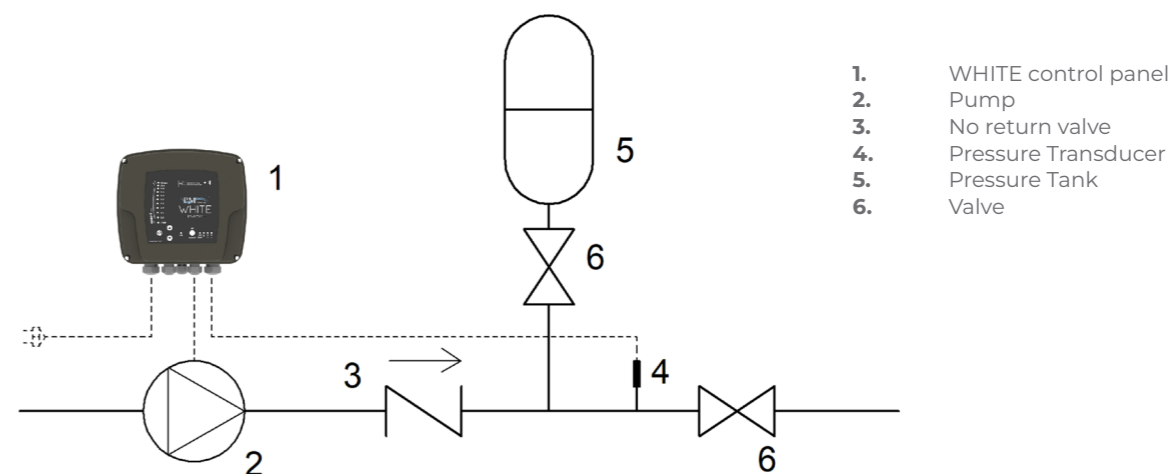

## CONTROL THROUGH PM MyConnect App

Thanks to PM MyConnect, it's possible to communicate with all WHITE series devices via Bluetooth®. This app has been specifically developed to:

- Set the nominal sizes of the electropump
- Display the operating parameters
- Program digital inputs and outputs to add functionality to the system
- Receive assistance
- Monitor the electrical consumption and the life hours of the electropump

## PM devices in your hands.

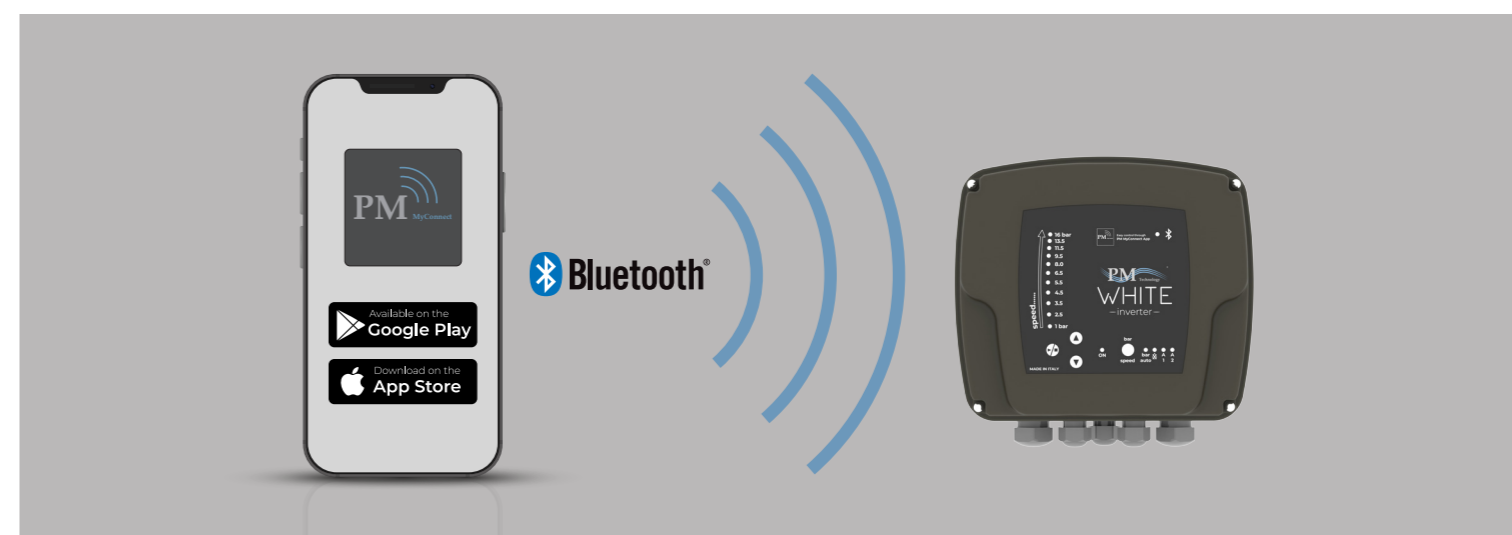

"The Bluetooth® word mark and logos are registered trademarks owned by Bluetooth SIG, Inc. and any use of such marks by PM S.r.l. is under license. Other trademarks and trade names are those of their respective owners."

**SACRIFICIAL ANODE**

Model	Code	Description
	ANODE4OM	<p><b>DESIGNED FOR THE SERIES OF 4" OIL FILLED SUBMERSIBLE MOTORS 4OM, 4OM2W, 4OME, 4OME SOLAR</b></p> <p>This special anode, made in "cadmium free" zinc-aluminium, protects motor from corrosion caused by stray currents or by usage in particularly aggressive waters.</p> <p>It's been designed to be easily applied to the lower end of the motor, allowing a quick installation just in case of need.</p>
	ANODEFROG	<p><b>DESIGNED FOR THE SERIES OF ELECTRO-PUMPS 5" FROG</b></p> <p>This special anode, made in "cadmium free" zinc-aluminium, protects the 5" electropump FROG from corrosion caused by stray currents or by usage in particularly aggressive waters.</p> <p>It's been designed to be easily applied to the lower end of the 5" electropump FROG, allowing a quick installation just in case of need.</p>

**CAPACITORS**

Model	Code	µF	Voltage	Frequency	Description
	CAP20	20	450V C-Class	50/60 Hz	
	CAP25	25	450V C-Class	50/60 Hz	
	CAP35	35	450V C-Class	50/60 Hz	
	CAP40	40	450V C-Class	50/60 Hz	Capacitors with flexible leads of 100 mm length and watertight end.
	CAP60	60	450V C-Class	50/60 Hz	
	CAP70	70	450V C-Class	50/60 Hz	
	CAP80	80	450V C-Class	50/60 Hz	

**CABLES FOR SUBMERSIBLE MOTORS AND ELECTROPUMPS**

Model	Code	Length [m]	Section [mm²]	Description
	<b>4OM</b>	<b>4WM</b>		
	0703402	0704031	1,7	1,5
	0703403	0704032	2,7	2
	0703404	0704033	3,5	2
	0703405	0704034	10	1,5
	0703406	0704035	20	1,5
	0703407	0704036	20	2
	0703408	0704037	30	1,5
	0703409	0704038	30	2
	0703411	0704039	50	1,5
	0703412	0704040	50	2
	<b>6OM</b>			
	0603401		3	4
	0603403		4	8
	0603414		10	4
	0603415		10	8
	0603408		30	4
	0603409		30	8
	0603410		50	4
	0603411		50	8
	0603416		80	4
	0603417		80	8
	<b>4OM2W</b>	<b>4WM2W</b>		
	0703441	0704010	1,5	1,5
	0703442	0704011	20	1,5
	0703443	0704012	30	1,5
	<b>4OME</b>	<b>4OME SOLAR</b>		
		0703471	1,5	1,5
		0703473	30	1,5
	<b>FROG</b>			
	1101710		10	1
	5" FROG cable 1-ph with Shuko plug			
	1101711		20	1
	5" FROG cable 1-ph with Shuko plug			
	1101720		10	1
	5" FROG cable 3-ph			
	1101721		20	1
	5" FROG cable 3-ph			

**CABLE WITH CONNECTOR FOR THE SERIES OF SUBMERSIBLE MOTORS 4OM, 4WM, 4OM2W, 4WM2W, 4OME, 4OME SOLAR AND 6OM**

Blue flat cable made in cross-linked gum with connector for submersible motor.

Usable up to about 250 meters depth, even in drinking water.

All cables are homologated ACS, KTW, WRAS.

**CABLE WITH CABLE GLAND CONNECTOR FOR THE SERIES OF ELECTRO-PUMPS 5" FROG**

H07 RN-F cable with connector for fast and easy connection to electropumps.

Single-phase versions with Schuko plug end. Different plugs upon request.

**FLOAT SWITCH FROG**

Model	Code	Description
	1101702	<p><b>FLOAT SWITCH WITH CABLE GLAND CONNECTOR FOR THE SERIES OF ELECTROPUMPS 5" FROG</b></p> <p>Float switch with H07RN-F cable and connector for easy connection and removal.</p> <p><b>MAX. USAGE DEPTH</b> 40 m</p>

**PLUG CONNECTOR WITH FERRULE FROG**

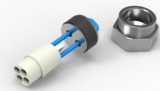
Model	Code	Description
	1101703KIT	<p><b>PLUG CONNECTOR WITH FERRULE FOR THE SERIES OF ELECTROPUMPS 5" FROG</b></p>

**DISASSEMBLY KIT FROG**

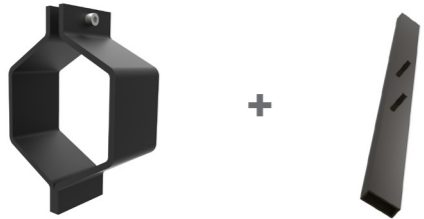
Model	Code	Description
	0103101	<p><b>DISASSEMBLY KIT FOR THE SERIES OF ELECTROPUMPS 5" FROG</b></p> <p>This kit helps all installers to repair their FROG 5" submersible electropump.</p>

**PRESSURE TRANSDUCER 40ME**

Model	Code	Description
	0703001	<p><b>PRESSURE TRANSDUCER FOR THE SERIES OF 4" OIL FILLED SUBMERSIBLE MOTORS 40ME</b></p> <p>0-16 bar 4-20 mA IP 65.</p>





# cables sizing charts

## 4" MOTORS CABLES SIZING CHART

Rated power		Rated Voltage V	Cable section mm²							
kW	Hp		1	1,5	2,5	4	6	10	16	25
<b>Maximum Length [m]</b>										
0,37	0,5	<b>Single-phase 220-230 V (50/60 Hz)</b>	63	94	156	250	-	-	-	-
0,55	0,75		45	67	112	179	267	-	-	-
0,75	1		39	59	98	156	233	-	-	-
1,1	1,5		28	42	69	110	165	273	-	-
1,5	2		22	32	54	86	128	213	337	-
2,2	3		-	24	41	65	97	161	256	-
3,7	5	-	-	26	42	63	104	166	256	
0,37	0,5	<b>Single-phase 110-115 V (60 Hz)</b>	31,5	47	78	125	-	-	-	-
0,55	0,75		22,5	33,5	56	89,5	133,5	-	-	-
0,75	1		19,5	29,5	49	78	116,5	-	-	-
1,1	1,5	-	14	21	34,5	55	85,5	136,5	-	-
0,37	0,5	<b>Three-phase 220-230 V (50/60 Hz)</b>	94	140	233	-	-	-	-	-
0,55	0,75		67	100	167	266	-	-	-	-
0,75	1		53	80	134	215	-	-	-	-
1,1	1,5		42	63	104	166	247	-	-	-
1,5	2		38	57	98	151	225	-	-	-
2,2	3		30	45	75	119	177	292	-	-
3	4		23	34	56	90	134	220	347	-
4	5,5		-	25	41	66	98	162	256	-
5,5	7,5		-	-	31	49	73	120	189	290
0,37	0,5		-	270	405	-	-	-	-	-
0,55	0,75	-	192	288	-	-	-	-	-	-
0,75	1	-	155	234	-	-	-	-	-	-
1,1	1,5	-	120	180	298	-	-	-	-	-
1,5	2	-	109	163	271	-	-	-	-	-
2,2	3	-	86	129	214	341	-	-	-	-
3	4	-	47	96	160	255	381	-	-	-
4	5,5	-	35	71	118	188	280	463	-	-
5,5	7,5	-	-	52	87	139	207	342	-	-
7,5	10	-	-	40	66	105	157	260	411	-

## 40ME, 40ME SOLAR MOTORS CABLES SIZING CHART

Rated Voltage V	Cable section mm²							
	1	1,5	2,5	4	6	10	16	25
220-230 V	22	32	54	86	128	213	337	-

## 6" MOTORS CABLES SIZING CHART

Rated power		Rated Voltage V	Cable section mm²									
kW	Hp		4x2,5	4x4	4x6	4x8	4x10	4x16	4x25	4x35	4x50	4x70
<b>Maximum Length [m]</b>												
4.0	5.5	<b>Three-phase 380-400 V (50/60 Hz) Direct DOL</b>	180	290	430	570	710	-	-	-	-	
5.5	7.5		130	210	320	425	530	830	-	-	-	
7.5	10.0		90	150	230	310	390	610	940	-	-	
9.2	12.5		80	130	190	255	320	510	770	-	-	
11.0	15.0		60	100	160	215	270	430	650	890	-	
13.0	17.5		40	90	140	185	230	370	530	780	-	
15.0	20.0		-	80	120	160	200	320	490	680	920	
18.5	25.0		-	-	100	130	160	260	400	540	740	980
22.0	30.0		-	-	-	100	140	220	340	470	630	840
26.0	35.0		-	-	-	-	80	190	310	420	540	730
30.0	40.0	-	-	-	-	-	160	250	340	470	620	
37.0	50.0	-	-	-	-	-	100	160	210	310	400	
4.0	5.5	<b>Three-phase 380-400 V (50/60 Hz) Star/Delta</b>	270	430	640	845	-	-	-	-	-	
5.5	7.5		190	310	480	635	790	-	-	-	-	
7.5	10.0		130	220	340	460	580	910	-	-	-	
9.2	12.5		120	190	280	380	480	760	-	-	-	
11.0	15.0		90	150	240	320	400	640	970	-	-	
13.0	17.5		80	140	210	280	350	540	850	-	-	
15.0	20.0		70	120	180	240	300	480	730	1020	-	
18.5	25.0		60	90	150	195	240	390	600	810	-	
22.0	30.0		-	70	120	165	210	330	510	700	940	
26.0	35.0		-	50	100	140	180	290	430	610	800	
30.0	40.0	-	-	90	120	150	240	370	510	700	930	
37.0	50.0	-	-	60	75	90	150	230	320	460	720	
4.0	5.5	<b>Three-phase 220-230 V (50/60 Hz) Direct DOL</b>	31	59	95	134	172	276	427	-	-	
5.5	7.5		20	41	69	99	128	207	322	448	-	
7.5	10.0		-	27	47	70	92	151	236	331	477	
9.2	12.5		-	10	37	55	73	122	193	270	391	
11.0	15.0		-	-	28	44	59	100	160	225	326	450
13.0	17.5		-	-	12	30	48	83	134	190	277	383
15.0	20.0		-	-	8	25	41	72	117	168	245	341
18.5	25.0		-	-	-	-	22	58	95	136	200	277
22.0	30.0		-	-	-	-	14	46	78	113	167	234
26.0	35.0		-	-	-	-	26	62	91	136	191	265
30.0	40.0	-	-	-	-	-	52	78	117	165	228	
37.0	50.0	-	-	-	-	-	30	60	92	132	186	

# units conversion charts

## LENGTH

millimetre mm	centrimetre cm	metre m	inch in	foot ft	yard yd
1	0,1	0,001	0,0394	0,0033	0,0011
10	1	0,01	0,3937	0,0328	0,0109
1000	100	1	39,3701	3,2808	10,936
25,4	2,54	0,0254	1	0,0833	0,0278
304,8	30,48	0,3048	12	1	0,3333
914,4	91,44	0,9144	36	3	1

## VOLUME

cubic metre m³	litre l	millilitre ml	imp. gallon Imp. gal.	gallon US US gal	cubic foot ft³
1	1000	1 x 10 <sup>6</sup>	220	264,2	35,3147
0,001	1	1000	0,22	0,2642	0,0353
1 x 10 <sup>-6</sup>	0,001	1	2,2 x 10 <sup>-4</sup>	2,642 x 10 <sup>-4</sup>	3,53 x 10 <sup>-5</sup>
0,00455	4,546	4546	1	1,201	0,1605
0,00378	3,785	3785	0,8327	1	0,1337
0,0283	28,317	28317	6,2288	7,4805	1

## WEIGHT

kilogram kg	pound lb	hundredweight cwt	ton t	t long tn	t short sh. tn
1	2,205	0,0197	0,001	9,84 x 10 <sup>-4</sup>	0,0011
0,454	1	0,0089	4,54 x 10 <sup>-4</sup>	4,46 x 10 <sup>-4</sup>	5,0 x 10 <sup>-4</sup>
50,802	112	1	0,0508	0,05	0,056
1000	2204,6	19,684	1	0,9842	1,1023
1016	2240	20	1,0161	1	1,102
907,2	2000	17,857	0,9072	0,8929	1

## POWER

kilowatt Kw	horsepower Hp	watt w
1	1,34	1000
0,75	1	750
0,001	0,0013	1

## VOLUMETRIC FLOW RATE

litre second	litre minute	cubic metre hour	cubic foot hour	cubic foot minute	imp. gal. minute	US gal. minute	US barrel day (oil)
l/s	l/min	m³/h	ft³/h	ft³/min	Imp. gal/min	US gal/min	US barrel/g
1	60	3,6	127,133	2,1189	13,2	15,85	543,439
0,017	1	0,06	2,1189	0,0353	0,22	0,264	9,057
0,278	16,667	1	35,3147	0,5886	3,666	4,403	150,955
0,008	0,472	0,0283	1	0,0167	0,104	0,125	4,275
0,472	28,317	1,6990	60	1	6,229	7,480	256,475
0,076	4,546	0,2728	9,6326	0,1605	1	1,201	41,175
0,063	3,785	0,2271	8,0209	0,1337	0,833	1	34,286
0,002	0,110	0,0066	0,2339	0,0039	0,024	0,029	1

## PRESSURE AND PREVALENCE

Newton square metre N/m²	kiloPascal	bar	kilogram force square centimetre	pound force square inch	foot of water	metre of water	millimetre mercury	inch mercury
(Pa)	kPa	bar	kgf/cm²	psi	ft H₂O	m H₂O	mm Hg	In Hg
1	0,001	1 x 10 <sup>-5</sup>	1,02 x 10 <sup>-5</sup>	1,45 x 10 <sup>-4</sup>	3,35 x 10 <sup>-4</sup>	1,02 x 10 <sup>-4</sup>	0,0075	2,95 x 10 <sup>-4</sup>
1000	1	0,01	1,02 x 10 <sup>-2</sup>	0,145	0,335	0,102	7,5	0,295
100000	100	1	1,02	14,5	33,52	10,2	750,1	29,53
98067	98,07	0,981	1	14,22	32,81	10	735,6	28,96
6895	6,895	0,069	0,0703	1	2,31	0,703	51,72	2,036
2984	2,984	0,03	0,0305	0,433	1	0,305	22,42	0,882
9783	9,789	0,098	0,1	1,42	3,28	1	73,42	2,891
133,3	0,133	0,0013	0,014	0,019	0,045	0,014	1	0,039
3386	3,386	0,338	0,345	0,491	1,133	0,345	25,4	1



# condizioni generali di vendita

**1. Ordini** - Gli ordini si intendono definitivi e impegnativi solo se espressamente confermati per iscritto dalla PM S.r.l. ed ulteriormente confermati dal Cliente qualora il Fornitore abbia apportato modifiche all'ordine ricevuto.

**2. Prezzo** - Il prezzo della fornitura è quello risultante dal listino prezzi in vigore al momento dell'invio dell'ordine, oppure quello negoziato dalle parti e risultante nella conferma d'ordine. Se non diversamente stabilito, il prezzo della fornitura si intende per merce imballata secondo gli usi del settore in relazione al mezzo di trasporto pattuito, essendo anche inteso che qualsiasi altra spesa o onere per richieste particolari sarà a carico del Cliente.

**3. Trasporto della merce** - Qualora sia stata convenuta una vendita con trasporto tramite vettore, indipendentemente da colui che incarica il vettore, i rischi passano al Cliente con la consegna della merce al primo Vettore: eventuali reclami per rotture, deterioramenti, manomissioni o mancanze dovranno essere denunciati sempre al Vettore nei termini di legge previsti, dandone comunque opportuna conoscenza alla PM S.r.l..

**4. Termini di consegna** - Salvo differente accordo, i termini di consegna previsti nell'ordine sono puramente indicativi e non essenziali; eventuali ritardi nella consegna per:

- cause di forza maggiore
- ritardi di approvvigionamento delle materie prime
- eventuali variazioni dell'ordine richieste in fase di produzione
- inadempienza ai pagamenti da parte del Committente

sollevano comunque il Fornitore dal rispetto dei termini concordati non potranno dare diritto ad indennizzi e/o risarcimenti di alcun genere.

**5. Pagamenti** - I pagamenti devono essere compiuti esclusivamente al Fornitore alle condizioni convenute o richiamate nell'ordine. È inteso che eventuali reclami o contestazioni non danno diritto al Cliente di sospendere o comunque ritardare i pagamenti dei prodotti oggetto di contestazione, né, tanto meno, di altre forniture. Più in generale, nessuna azione od eccezione potrà essere svolta od opposta dal Cliente se non dopo l'integrale pagamento dei prodotti per i quali tale contestazione od eccezione si intende svolgere. Il Cliente non è autorizzato ad effettuare alcuna deduzione dal prezzo pattuito (ad es. in caso di pretesi difetti dei prodotti), se non previamente stabilito per iscritto con il Fornitore. In caso di ritardato pagamento alle scadenze pattuite verranno addebitati al Cliente, senza preavviso, gli interessi di mora in base alle aliquote previste per legge.

**6. Garanzia prodotti** - I prodotti vengono garantiti dal Fornitore per difetti progettuali, di materiale e di lavorazione, per un periodo di 24 mesi decorrenti dalla data apposta sull'etichetta del prodotto. Si ricorda che i prodotti devono essere installati da personale tecnico qualificato, pertanto non vengono coperte da garanzia avarie per installazioni con errati collegamenti elettrici, mancata protezione adeguata, montaggi difettosi oltre ai danni causati da installazioni compiute in ambienti non conformi alle specifiche comunicate dal Fornitore, corrosioni e/o abrasioni da parte del liquido pompato, sovraccarichi oltre i limiti di targa e cause di forza maggiore in generale. La garanzia decade nei casi in cui il cliente sia inadempiente nei pagamenti, siano state apportati manomissioni o interventi al prodotto da parte di terzi non autorizzati, il danno venga comunicato oltre i termini previsti al punto seguente.

**7. Contestazioni** - I prodotti acquistati devono essere verificati e controllati all'arrivo per la loro conformità all'ordine. Discordanze eventuali, riguardanti la quantità, la specie o il tipo dei prodotti forniti nonché eventuali reclami concernenti le caratteristiche esteriori dei prodotti, dovranno essere sempre denunciati per iscritto, nel termine massimo di 8 giorni dal loro ricevimento, citando tutti gli estremi per un immediato controllo. Trascorso tale termine, i prodotti verranno considerati a tutti gli effetti accettati; inoltre, l'avvenuto uso e/o installazione dei prodotti che presentino difetti palesi, esclude la possibilità di contestazioni o reclami riguardanti i difetti stessi. I difetti o vizi dei prodotti, non accertabili in base a diligente verifica esteriore degli stessi, devono essere denunciati per iscritto al Fornitore, a pena di decadenza, entro 8 giorni dalla loro scoperta, ed in ogni caso non oltre il termine di garanzia sopra previsto. Ogni eventuale reclamo deve specificare con precisione il difetto riscontrato; i prodotti oggetto della contestazione devono essere sempre messi a disposizione degli incaricati del Fornitore per la loro verifica. Le contestazioni non comporteranno la risoluzione del singolo ordine, bensì, a discrezione del Fornitore, la riparazione o sostituzione gratuita dei prodotti risultati difettosi, salvo diversa decisione dovuta a ragioni obiettive di impossibilità di adottare uno dei rimedi sopra previsti. Fatti salvi i casi di dolo o colpa grave, quanto sopra disposto esclude ogni altra responsabilità del Fornitore comunque originata dai prodotti forniti o dalla loro rivendita. In particolare, non potranno essere pretesi risarcimenti e/o indennizzi per danni, diretti o indiretti, di qualsiasi natura derivanti dal mancato o limitato utilizzo dei prodotti. Eventuali contestazioni riguardanti una singola consegna non esonerano il Cliente dall'obbligo di ritirare la restante quantità di prodotti prevista dallo specifico ordine, oppure da altri ordini distinti da quello in esame.

**8. Resi di merce** - Il Fornitore non accetta resi di merce se non preliminarmente autorizzati dallo stesso per iscritto. I resi devono comunque essere integri (non smontati), imballati (possibilmente nella confezione originale) e accompagnati da bolla di reso, assumendosene il Cliente tutti i costi e rischi.

**9. Sospensione o annullamento degli ordini** - Qualora il Cliente non rispettasse, anche solo in parte, una delle condizioni generali stabilite per la fornitura, come pure in caso di constatata difficoltà nei pagamenti ovvero venissero a mancare o diminuissero le garanzie di solvibilità o, più in generale, la sua capacità economica, è facoltà del Fornitore di sospendere o annullare gli ordini in corso, ovvero di subordinare la consegna dei prodotti alla prestazione di adeguate garanzie di pagamento.

# general sales conditions

**1. Orders** - Orders are considered definitive and binding only if expressly confirmed in writing by PM S.r.l., and further confirmed by the Customer if Supplier makes changes to the order received.

**2. Price** - The price of supply refers to price list in effect at the time the order is sent, or the price agreed by the parties and printed in the order confirmation. Unless otherwise stated, the price of the supply is understood to be for goods packaged according to sector uses with reference to the agreed means of transport. It's also understood that further expenses or charges for special requests will be at the expense of the Customer.

**3. Transport of goods** - If a sale has been agreed by carrier, regardless the part designating the carrier, risks move to the Customer with the delivery of the goods to the first Carrier: any claims for damages, deterioration, tampering or lacks must always be reported to the Carrier in accordance with the law deadlines and providing, however, appropriate knowledge to PM S.r.l..

**4. Terms of delivery** - Unless otherwise agreed, delivery terms printed in the order are purely indicative and not essential; any delays in delivery for:

- reasons due to force majeure
- delays in raw materials supply
- any changes in the order due to requests during production
- defaulting Customer in payments

relieve Supplier from compliance with the agreed terms and can not give the right to any kind of reimbursement and/or compensation.

**5. Payments** - Payments must be made exclusively to the Supplier according to the terms agreed or printed in the order. It is understood that any complaints or disputes don't entitle the Customer in any case to suspend or delay payments of the products in question or, not even, of other supplies. More generally, no action or exception can be carried out or opposed by the Customer until the full payment of the products for which this complaint or exception is intended to be carried out. The Customer is not authorized to make any deductions from the agreed price (for example, in case of supposed product defects), unless previously agreed in writing with the Supplier. In case of delayed payment at the agreed deadlines, default interests will be debited to the Client on the basis of the established rates by law.

**6. Product warranty** - Products are guaranteed by the Supplier for design, material and processing defects, for a period of 24 months starting from the date printed on product label. Please remind that products must be installed by qualified technical employees, therefore damages due to installations with wrong electrical connections, missed adequate protection, faulty assembly as well as damages caused by installations carried out in locations not complying with the specifications communicated by the Supplier, corrosion and/or abrasion due to pumped liquid, overloads beyond plate limits and causes of force majeure in general are not covered by warranty. The warranty is void if Customer is defaulting in payments, if unauthorized third parties have tampered with product or made action on it, if damages is communicated beyond the deadlines specified in the following point.

**7. Complaints** - Products purchased must be verified and checked upon arrival about their compliance with the order. Any discrepancies, regarding the quantity, kind or type of products supplied and any complaints concerning the external characteristics of the products, must always be reported in writing, within a maximum of 8 days from receipt, mentioning all the details for an immediate control. After this deadline, products will be considered accepted; in addition, the possibility of claims or complaints regarding defects or damaged is totally excluded in case of use and/or installation of products with obvious defects. Defects or faults of the products, not assertable even if a diligent external verification have been carried out, must be reported in writing to the Supplier, under penalty of forfeiture, within 8 days after discovery, and in any case not later than the warranty term above. Any complaint must accurately specify the defect found; products object of the complaints have always to be available of the Supplier for their verification. Protests will not entail in the resolution of the single order, but rather, at Supplier discretion, the reparation or free replacement of the faulty products, unless other decision due to objective reasons of impossibility to implement one of the above remedies. Except for fraud or gross negligence, the foregoing excludes any other responsibility of the Supplier that can be originated from supplied products or their resale. In particular, reimbursement and/or compensation for damages, direct or indirect, of any nature deriving from the non-use or limited use of products can not be claimed. Any protest regarding a single delivery do not relieve the Customer from the duty to collect the outstanding quantity of products of that order, or from other orders different than one in question.

**8. Returned goods** - Supplier does not accept returns of goods unless previously authorized in writing by Supplier himself. However, returns must be intact (not disassembled), packed (in the original packaging if possibly) and shipped with goods return note, at all Customer charges and risks.

**9. Suspension or cancellation of orders** - If the Customer, in whole or in part, does not comply with one of the general conditions agreed for the supply, as well as in case of difficulty in payments, if guarantees of solvency, or more in general its economic capacity, fails or decreases, Supplier has the right to suspend or cancel underway orders, or to subordinate delivery of products to adequate guarantees of payment.



PM S.r.l.

Via A. Volta, 8  
36040 Brendola (VI) - Italy  
T. +39 0444 673043  
F. +39 0444 677273  
info@pmtechnology.eu  
www.pmtechnology.eu  
Società sottoposta alla direzione e coordinamento di  
PEDROLLO GROUP S.r.l.



© COPYRIGHT PM S.r.l.

Tutti i diritti riservati.  
Tutte le informazioni riportate nel presente catalogo sono indicative;  
PM S.r.l. si riserva il diritto di variare i dati esposti in qualsiasi momen-  
to e senza dovere di preavviso.  
All rights reserved.  
All information shown in this catalogue are purely indicative;  
PM S.r.l. reserves the right to make any necessary variation without  
prior notice.



EDIT: CATALOGUE/MAR/2024

